

# Bathmood

Mirage Design Furniture



**MIRAGE**<sup>®</sup>  
Porcelain. Design. Sustainability

# Bathmood

Mirage Design Furniture

**MIRAGE**<sup>®</sup>  
Porcelain.Design.Sustainability





# > more than furniture

**Con il progetto Bathmood, Mirage® esplora le potenzialità del grès porcellanato per offrire soluzioni di interior design perfettamente coordinabili con pavimenti e rivestimenti.**

**Linee essenziali e prestazioni tecniche d'eccellenza per applicazioni destinate a differenti tipologie di ambienti, sia in ambito residenziale che commerciale.**

> EN

With the Bathmood project, Mirage® explores further possibilities of porcelain stoneware to offer interior design solutions that can be perfectly coordinated with floors and coverings.

Essential lines and excellent technical qualities for applications for different types of environment, both residential and commercial.

> DE

Mit dem Projekt Bathmood erkundet Mirage® die Ausdrucksmöglichkeiten von Feinsteinzeug, um Lösungen für die Innenarchitektur zu bieten, die sich perfekt auf Bodenbeläge und Wandverkleidungen abstimmen lassen.

Puristische Schlichtheit und ausgezeichnete technische Leistung für Anwendungen in verschiedenen Kontexten, sowohl im privaten als auch im gewerblichen Bereich.

> FR

Avec le projet Bathmood, Mirage® explore les potentialités du grès cérame pour offrir des solutions de design d'intérieur parfaitement coordonnables avec les sols et les revêtements.

Des lignes essentielles et des prestations techniques d'excellence pour des applications destinées à différentes typologies d'espace, dans un cadre résidentiel ou commercial.

> 中國

通过Bathmood系列，Mirage®探索了瓷质砖的表现潜力，以提供可与地砖和墙砖完美搭配的室内设计解决方案。

简洁、简约的线条以及出色的技术性能，可满足住宅和商业领域不同类型环境的应用需求。



lavabi  
washbasins



specchi  
mirrors



piatti doccia  
shower trays



pensili -sedute  
wall units - seats



## > a complete range

**Bathmood prevede una ricca selezione di lavabi da appoggio o freestanding, piatti doccia, specchi, mobili contenitori e sedute, tutti combinabili tra loro e disponibili in molteplici dimensioni.**

**Un programma flessibile ed in continua evoluzione, dove le molteplici possibilità di configurazione generano composizioni praticamente infinite e soluzioni specifiche per ogni esigenza.**

> EN

Bathmood offers a rich selection of leaning or freestanding washbasins, shower trays, mirrors, container furnitures and seats, all combinable between them and available in several sizes.

A flexible and continuously evolving programme, in which the multiple configuration possibilities generate practically infinite compositions and solutions specific for each need.

> DE

Bathmood umfasst eine reiche Auswahl an Aufsatz- oder freistehenden Waschbecken, Duschwannen, Spiegeln, Schränken und Sitzmöbeln, die alle miteinander kombiniert werden können und in verschiedenen Größen erhältlich sind.

Ein flexibles und sich ständig weiterentwickelndes Programm, bei dem die vielfältigen Konfigurationsmöglichkeiten praktisch unendliche Kompositionen und spezifische Lösungen für jeden Bedarf erlauben.

> FR

Bathmood prévoit une riche sélection de lavabos à poser ou autoportants, de receveurs de douche, de miroirs, de meubles de rangement et d'assise, tous combinables entre eux et disponibles en nombreuses dimensions.

Un programme flexible et en constante évolution, où les nombreuses possibilités de configuration génèrent des compositions pratiquement infinies et des solutions spécifiques pour toutes les exigences.

> 中國

Bathmood系列提供多种多样的台上盥洗盆或独立式盥洗盆、淋浴盆、镜子、储物柜和座椅，它们可以相互组合使用，并具有多种尺寸。这个灵活且不断发展的系列，配置变化多端，可进行几乎无限的组合和具体的解决方案，满足任何需求。



# > endless possibilities

Una articolata gamma di colori, effetti e superfici, in grado di assecondare i gusti e le esigenze estetiche più diverse attraverso abbinamenti coordinati o contrasti mix&match.

> EN  
A structured range of colours, effects and finishes, able to satisfy the most varied tastes and aesthetic needs through coordinated combinations or mix&match contrasts.

> DE  
Eine umfassende Palette von Farben, Effekten und Oberflächen abgerundet, die durch koordinierte Kombinationen oder Mix&Match-Kontraste die unterschiedlichsten Vorlieben und ästhetischen Bedürfnisse erfüllen.

> FR  
Une gamme complète de couleurs, d'effets et de surfaces, en mesure de satisfaire les goûts et les exigences esthétiques les plus diverses à travers des assortiments coordonnés ou des contrastes mix&match.

> 中國  
丰富多样的颜色、效果和表面处理，可增强功能性设计，通过协调的组合或精致的混搭，可以满足最多样化的品味和审美需求。

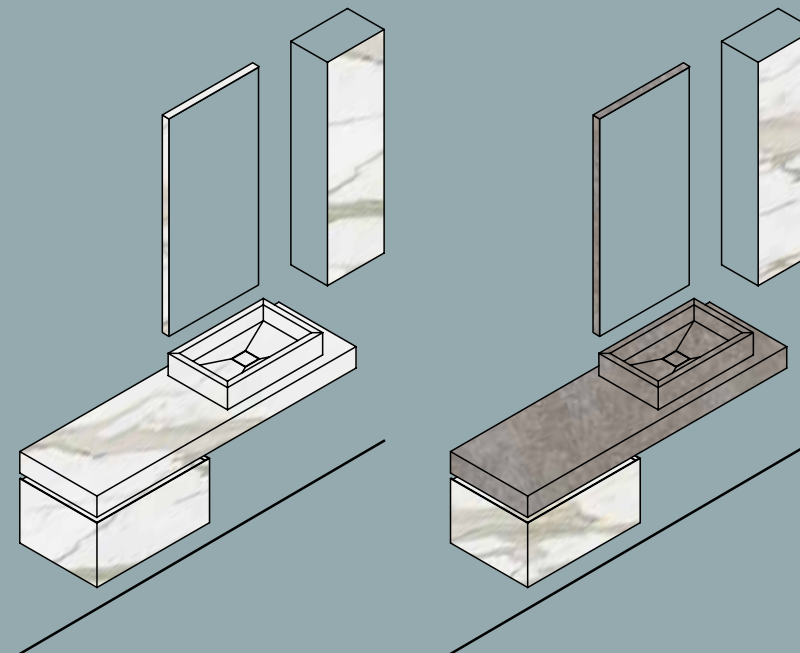

# > safe, hygienic, unique

**Bathmood significa anche tutela del nostro benessere.**

**Il grès porcellanato Mirage è infatti un materiale salubre e sicuro, grazie alle caratteristiche proprie del prodotto e al suo ciclo di lavorazione.**

**Facile da pulire e anallergico, garantisce elevatissimi standard di igiene in quanto ostacola la proliferazione di batteri e non rilascia sostanze nocive per la salute (VOC Free).**



**Facile da pulire**  
Easy to clean



**Non contiene allergeni**  
Does not contain Allergens



**Inospitale per batteri**  
Hostile to bacteria



**Non emette VOC**  
It does not release VOCs

> EN

Bathmood also means safeguarding our wellbeing. Mirage porcelain stoneware is, in fact, a healthy and safe material, thanks to the product's inherent characteristics and its processing cycle.

Easy to clean and hypoallergenic, it guarantees the highest standards of hygiene as it blocks the proliferation of bacteria and doesn't release substances harmful to health (VOC Free).

> DE

Bathmood bedeutet aber auch, unser Wohlbefinden zu schützen. Das Feinsteinzeug von Mirage ist nämlich, dank der besonderen Eigenschaften des Produkts und seines Verarbeitungszyklus, ein gesundes und sicheres Material. Es ist leicht zu reinigen und hypoallergen und garantiert sehr hohe Hygienestandards, da es die Vermehrung von Bakterien hemmt und keine gesundheitsschädlichen Stoffe freisetzt (VOC-frei).

> FR

Bathmood signifie également la protection de notre bien-être. Le grès cérame Mirage est en effet un matériau sain et sûr, grâce aux caractéristiques propres du produit et à son cycle de fabrication.

Facile à nettoyer et anallergique, il garantit des standards d'hygiène très élevés du fait qu'il empêche la prolifération des bactéries et n'émet pas de substances nocives pour la santé (VOC Free).

> 中國

Bathmood系列还意味着保护我们的健康和环境。由于产品的特性及其加工周期，Mirage瓷质砖实际上是一种健康安全材料。该系列的产品易清洁、防过敏，可确保最高的卫生标准，因为它可阻止细菌繁殖，并且不会释放有害健康的物质（不含挥发性有机化合物）。





# > DELIGHT

Lavabo ad appoggio freestanding con finitura in rovere termotrattato o laminato, anta apribile DX/SX

Freestanding washbasin, heat-treated oak finish, right/left side door opening

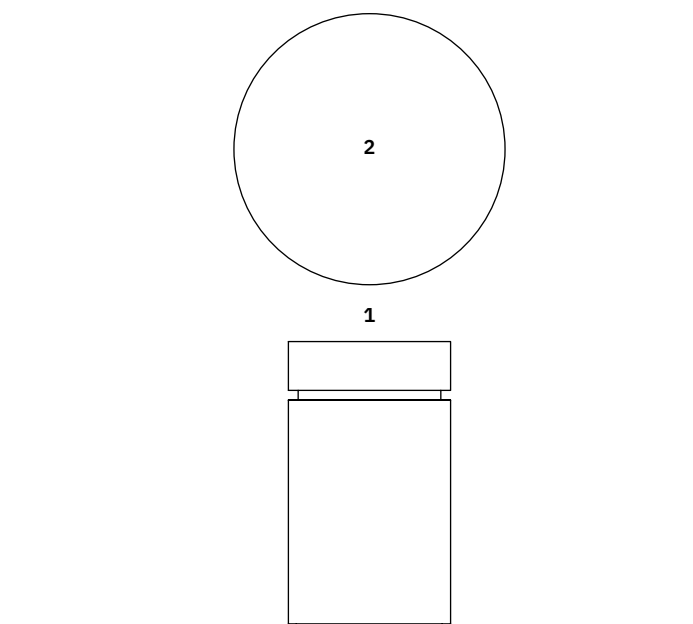

1 > DELIGHT DLQ50R

Gamma completa, dimensioni e finiture disponibili: pag. 79  
Complete range, sizes and available finishes: p. 79

2 > BLISS MRØ90

Gamma completa, dimensioni e finiture disponibili: pag. 94-95  
Complete range, sizes and available finishes: p. 94-95

FINITURE IMMAGINE | PICTURE FINISHES



1 > JEWELS Raymi JW 16 LUC

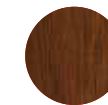

1 > Rovere Termotrattato | Heat-treated oak finish

Ogni elemento della composizione può essere acquistato singolarmente o in abbinamento e personalizzato con i prodotti Mirage® indicati alle pagine 99-111.  
Each element of the composition can be purchased individually or to match, and can be produced with all the Mirage® products indicated on pages 99-111.





12



13

**> DELIGHT**

**FINITURE IMMAGINE | PICTURE FINISHES**

**DELIGHT > JEWELS Raymi JW 16 LUC**  
Rovere Termotrattato | Heat-treated oak

**Floor > SILVERLAKE Orsi SK 06 NAT SQ**  
600x600 | 24"x24" - ± 9 mm  
150x600 | 6"x24" - ± 9 mm

**Wall > JEWELS Raymi JW 16 LUC SQ**  
1200x2780 | 48"x110" ± 6 mm



# > DELIGHT GRES

Lavabo ad appoggio freestanding, vano interno con ripiano ed anta apribile DX/SX

Freestanding washbasin, internal compartment with shelf and right/left side door opening

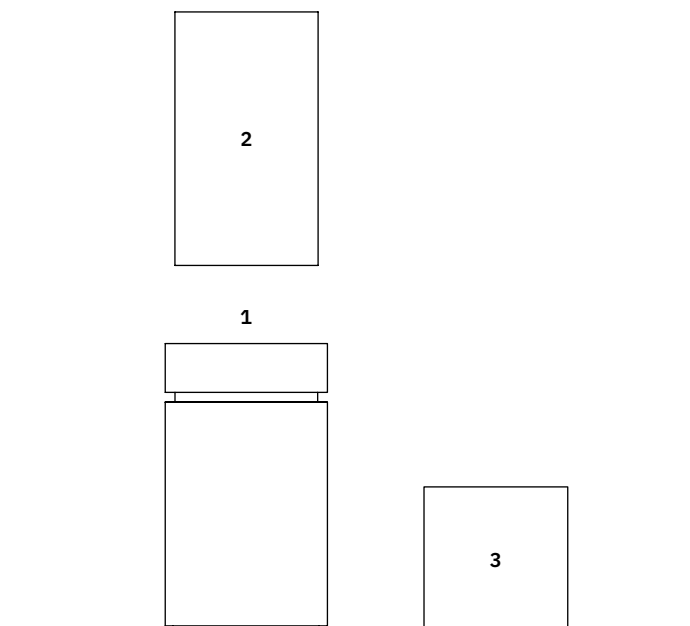

## FINITURE IMMAGINE | PICTURE FINISHES

### 1 > DELIGHT DLQ50G

Gamma completa, dimensioni e finiture disponibili: pag. 79  
Complete range, sizes and available finishes: p. 79

### 2 > BLISS MR4590

Gamma completa, dimensioni e finiture disponibili: pag. 94-95  
Complete range, sizes and available finishes: p. 94-95

### 3 > STAY STQ40

Gamma completa, dimensioni e finiture disponibili: pag. 98  
Complete range, sizes and available finishes: p. 98



1 > COSMOPOLITAN Statuario Fantastico CP 04 LUC



1 > GLOCAL Classic GC 05 SP



2 > COSMOPOLITAN Statuario Fantastico CP 04 LUC



3 > COSMOPOLITAN Statuario Fantastico CP 04 LUC

Ogni elemento della composizione può essere acquistato singolarmente o in abbinamento e personalizzato con i prodotti Mirage® indicati alle pagine 99-111.  
Each element of the composition can be purchased individually or to match, and can be produced with all the Mirage® products indicated on pages 99-111.



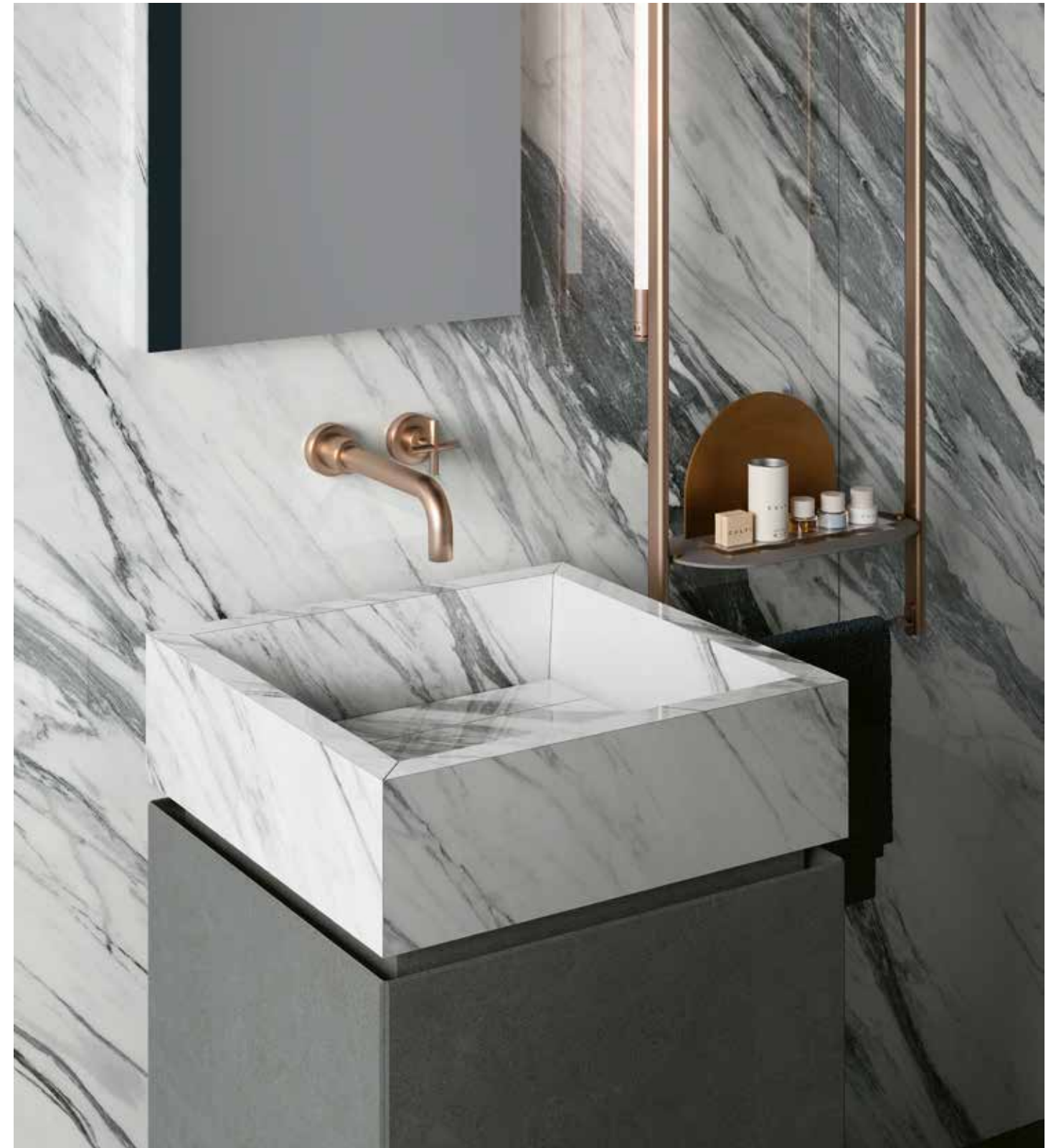

16

17

FINITURE IMMAGINE | PICTURE FINISHES

**DELIGHT** > **COSMOPOLITAN** Statuario Fantastico **CP 04** LUC  
**GLOCAL** Classic **GC 05** SP

**BLISS** > **COSMOPOLITAN** Statuario Fantastico **CP 04** LUC

**STAY** > **COSMOPOLITAN** Statuario Fantastico **CP 04** LUC

**Floor** > **GLOCAL** Classic **GC 05** SP SQ  
1200x1200 | 48"x48" ± 9 mm

**Wall** > **COSMOPOLITAN** Statuario Fantastico **CP 04** LUC  
1200x2780 | 48"x110" ± 6 mm

**> DELIGHT**  
**GRES**



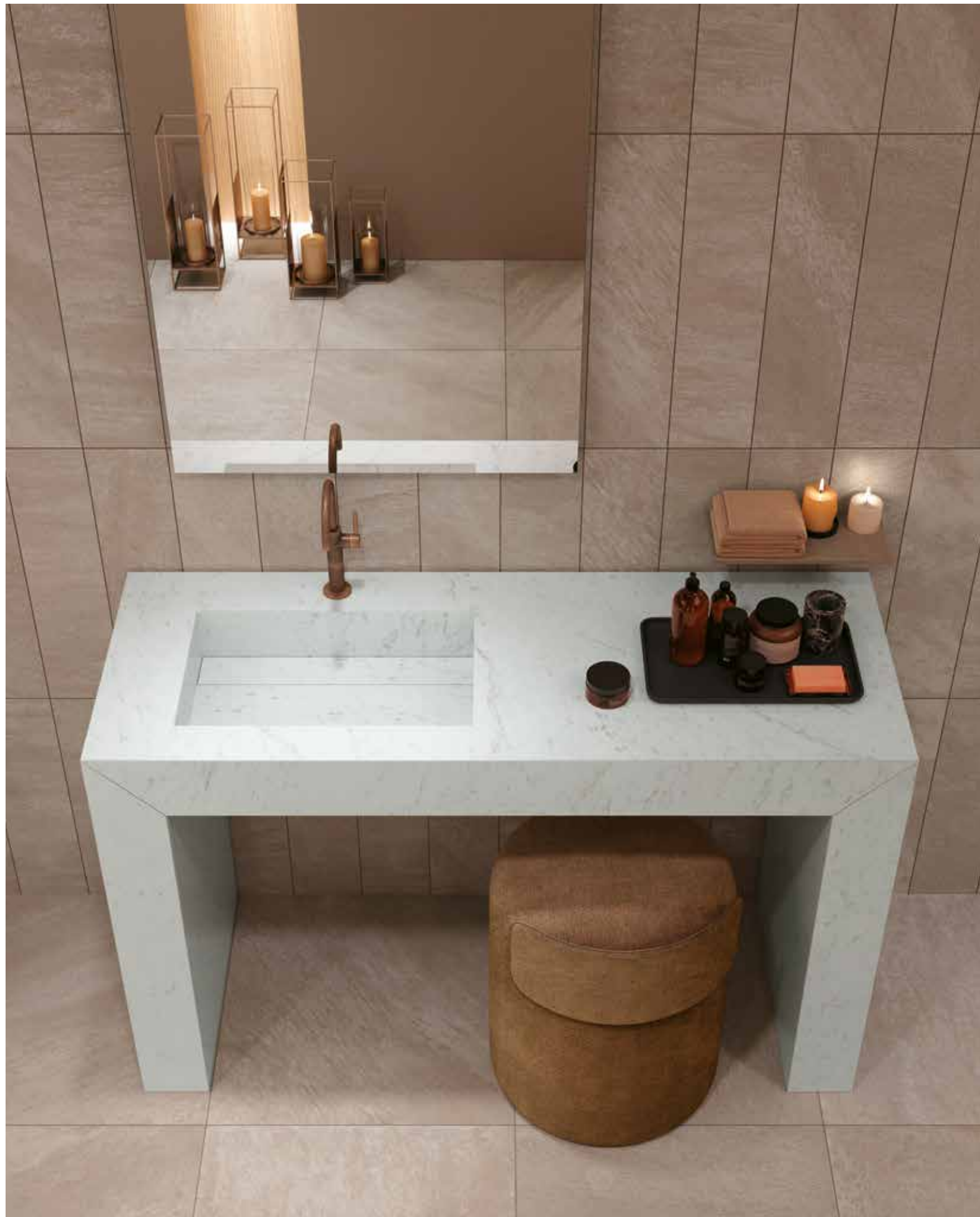

# > WONDER

**Consolle con lavabo integrato**  
Console with built-in washbasin

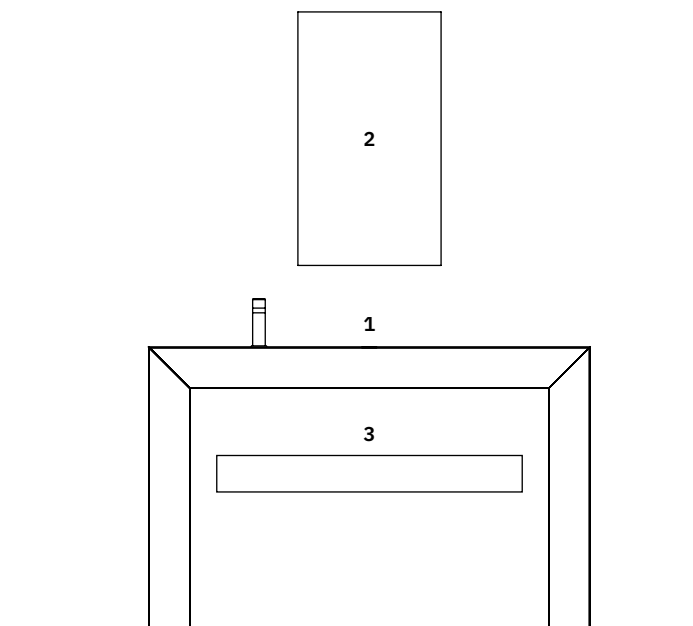

**FINITURE IMMAGINE | PICTURE FINISHES**

**1 > WONDER WD120S**

Gamma completa, dimensioni e finiture disponibili: pag. 92-93  
Complete range, sizes and available finishes: p. 92-93

**2 > BLISS MR6090**

Gamma completa, dimensioni e finiture disponibili: pag. 94-95  
Complete range, sizes and available finishes: p. 94-95



**1 > JEWELS Gioia White JW 13 LUC**



**2 > GLOCAL Chamois GC 08 SP**



**3 > Mensola in Quercia (Opzionale)**  
Oak Shelf (Optional)

Ogni elemento della composizione può essere acquistato singolarmente o in abbinamento e personalizzato con i prodotti Mirage® indicati alle pagine 99-111.  
Each element of the composition can be purchased individually or to match, and can be produced with all the Mirage® products indicated on pages 99-111.

THE SPA ROOM



FINITURE IMMAGINE | PICTURE FINISHES

WONDER > JEWELS Gioia White JW 13 LUC  
BLISS > GLOCAL Chamois GC 08 SP  
SMART > JEWELS Gioia White JW 13 LUC  
STAY > GLOCAL Chamois GC 08 SP

Floor > SILVERLAKE Resia SK 02 NAT SQ  
600x600 | 24"x24" | 9 mm  
Wall > SILVERLAKE Resia SK 02 NAT SQ  
150x600 | 6"x24" | 9 mm  
GLOCAL Clear GC 01 SP SQ  
1200x2780 | 48"x110" | 6 mm





# > WISH

**Top scatolare con lavabo singolo integrato e piano in appoggio laterale DX/SX**

Box-shaped countertop with built-in single washbasin and right/left side supporting surface

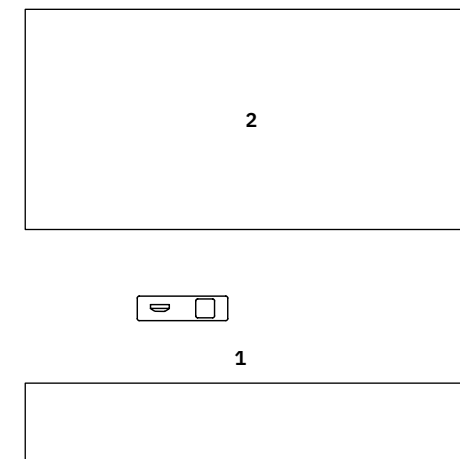

- 1 > WISH WH140S**  
Gamma completa, dimensioni e finiture disponibili: pag. 90-91  
Complete range, sizes and available finishes: p. 90-91
- 2 > BLISS MR14072**  
Gamma completa, dimensioni e finiture disponibili: pag. 94-95  
Complete range, sizes and available finishes: p. 94-95

**FINITURE IMMAGINE | PICTURE FINISHES**



**1 > LEMMY** Palladium **LY 01 SP**



**1 > GLOCAL** Absolute **GC 06 SP**  
Piano di appoggio | Supporting surface



**2 > GLOCAL** Absolute **GC 06 SP**

Ogni elemento della composizione può essere acquistato singolarmente o in abbinamento e personalizzato con i prodotti Mirage® indicati alle pagine 99-111.  
Each element of the composition can be purchased individually or to match, and can be produced with all the Mirage® products indicated on pages 99-111.



24



> **WISH**

FINITURE IMMAGINE | PICTURE FINISHES

- WISH** > **LEMMY** Palladium **LY 01** SP  
**GLOCAL** Absolute **GC 06** SP  
**Piano di appoggio** | Supporting surface
- BLISS** > **GLOCAL** Absolute **GC 06** SP
- Floor** > **NORR 2.0** Svart **RR 03** SP SQ  
1200x1200 | 48"x48" ± 9 mm
- Wall** > **NORR 2.0** Svart Fine **RR 13** SP SQ  
1200x1200 | 48"x48" ± 9 mm

25





# > WISH + FUN

Top scatolare con lavabo singolo integrato e piano in appoggio laterale DX/SX + Pensile con frontale in gres porcellanato

Box-shaped countertop with built-in single washbasin and right/left side supporting surface + wall unit

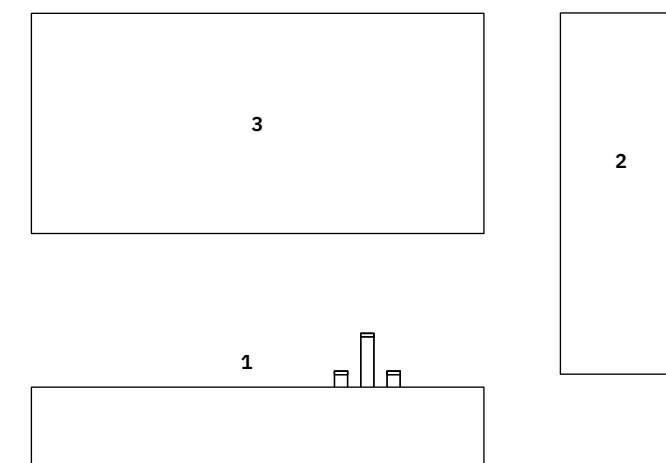

FINITURE IMMAGINE | PICTURE FINISHES

- 1 > **WISH** WH120D  
Gamma completa, dimensioni e finiture disponibili: pag. 90-91  
Complete range, sizes and available finishes: p. 90-91
- 2 > **FUN** FNR35104  
Gamma completa, dimensioni e finiture disponibili: pag. 97  
Complete range, sizes and available finishes: p. 97
- 3 > **BLISS** MR14072  
Gamma completa, dimensioni e finiture disponibili: pag. 94-95  
Complete range, sizes and available finishes: p. 94-95



1 > **COSMOPOLITAN** Statuario Extra CP 01 LUC



1 > **GLOCAL** Type GC 04 SP SQ  
Interno e piano di appoggio  
Interior and supporting surface



2 > **COSMOPOLITAN** Statuario Extra CP 01 LUC  
Frontale | Front panel



3 > **COSMOPOLITAN** Statuario Extra CP 01 LUC

Ogni elemento della composizione può essere acquistato singolarmente o in abbinamento e personalizzato con i prodotti Mirage® indicati alle pagine 99-111.  
Each element of the composition can be purchased individually or to match, and can be produced with all the Mirage® products indicated on pages 99-111.

## Bathmood



**> WISH**

FINITURE IMMAGINE | PICTURE FINISHES

**WISH** > **COSMOPOLITAN** Statuario Extra **CP 01** LUC  
**GLOCAL** Type **GC 04** SP SQ  
Interno e piano di appoggio | Interior and supporting surface

**FUN** > **COSMOPOLITAN** Statuario Extra **CP 01** LUC  
Frontale | Front panel

**BLISS** > **COSMOPOLITAN** Statuario Extra **CP 01** LUC

**Floor** > **GLOCAL** Type **GC 04** SP SQ  
600x600 | 24"x24" ± 9 mm

**Wall** > **COSMOPOLITAN** Statuario Extra **CP 01** LUC  
Bookmatch A+B 1200x2780 | 48"x110" ± 6 mm



# > GLEE

**Cassettiera sospesa con frontali rivestiti in gres porcellanato**

Wall-hung drawer unit with front panels covered in porcelain stoneware

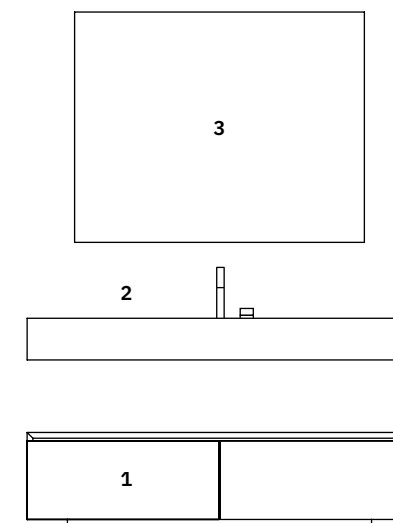

**FINITURE IMMAGINE | PICTURE FINISHES**

- 1 > **GLEE GE120**  
Gamma completa, dimensioni e finiture disponibili: pag. 85  
Complete range, sizes and available finishes: p. 85
- 2 > **JOY JY120TC**  
Gamma completa, dimensioni e finiture disponibili: pag. 88-89  
Complete range, sizes and available finishes: p. 88-89
- 3 > **BLISS MR9072**  
Gamma completa, dimensioni e finiture disponibili: pag. 94-95  
Complete range, sizes and available finishes: p. 94-95



1 > **CLAY Shy CL 06 SP**



2 > **CLAY Verve CL 05 SP**



3 > **CLAY Verve CL 05 SP**

Ogni elemento della composizione può essere acquistato singolarmente o in abbinamento e personalizzato con i prodotti Mirage® indicati alle pagine 99-111.  
Each element of the composition can be purchased individually or to match, and can be produced with all the Mirage® products indicated on pages 99-111.







32



33

> GLEE

FINITURE IMMAGINE | PICTURE FINISHES

- GLEE > CLAY Verve CL 05 SP
- JOY > CLAY Shy CL 06 SP
- BLISS > CLAY Verve CL 05 SP
- Floor > CLAY Shy CL 06 SP SQ  
600x600 | 24"x24" ± 9 mm
- Wall > CLAY Shy CL 06 SP SQ  
1200x2780 | 48"x110" ± 6 mm



# > GLAMOUR

**Monoblocco con lavabo integrato DX/SX**  
 Vanity unit with built-in left/right washbasin

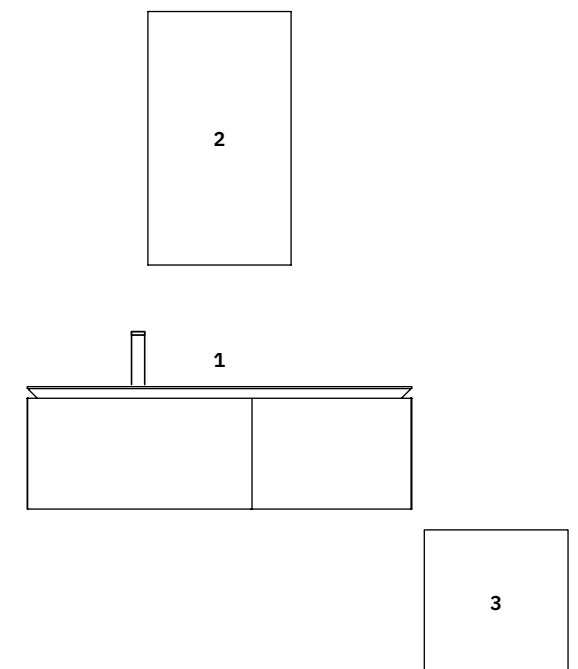

- 1 > GLAMOUR GM120S**  
 Gamma completa, dimensioni e finiture disponibili: pag. 84  
 Complete range, sizes and available finishes: p. 84
- 2 > BLISS MR6090**  
 Gamma completa, dimensioni e finiture disponibili: pag. 94-95  
 Complete range, sizes and available finishes: p. 94-95
- 3 > STAY STR6090**  
 Gamma completa, dimensioni e finiture disponibili: pag. 98  
 Complete range, sizes and available finishes: p. 98

**FINITURE IMMAGINE | PICTURE FINISHES**



- 1 > GLOCAL Classic GC 05 SP**
- 2 > GLOCAL Classic GC 05 SP**
- 3 > GLOCAL Classic GC 05 SP**

Ogni elemento della composizione può essere acquistato singolarmente o in abbinamento e personalizzato con i prodotti Mirage® indicati alle pagine 99-111.  
 Each element of the composition can be purchased individually or to match, and can be produced with all the Mirage® products indicated on pages 99-111.



> GLAMOUR

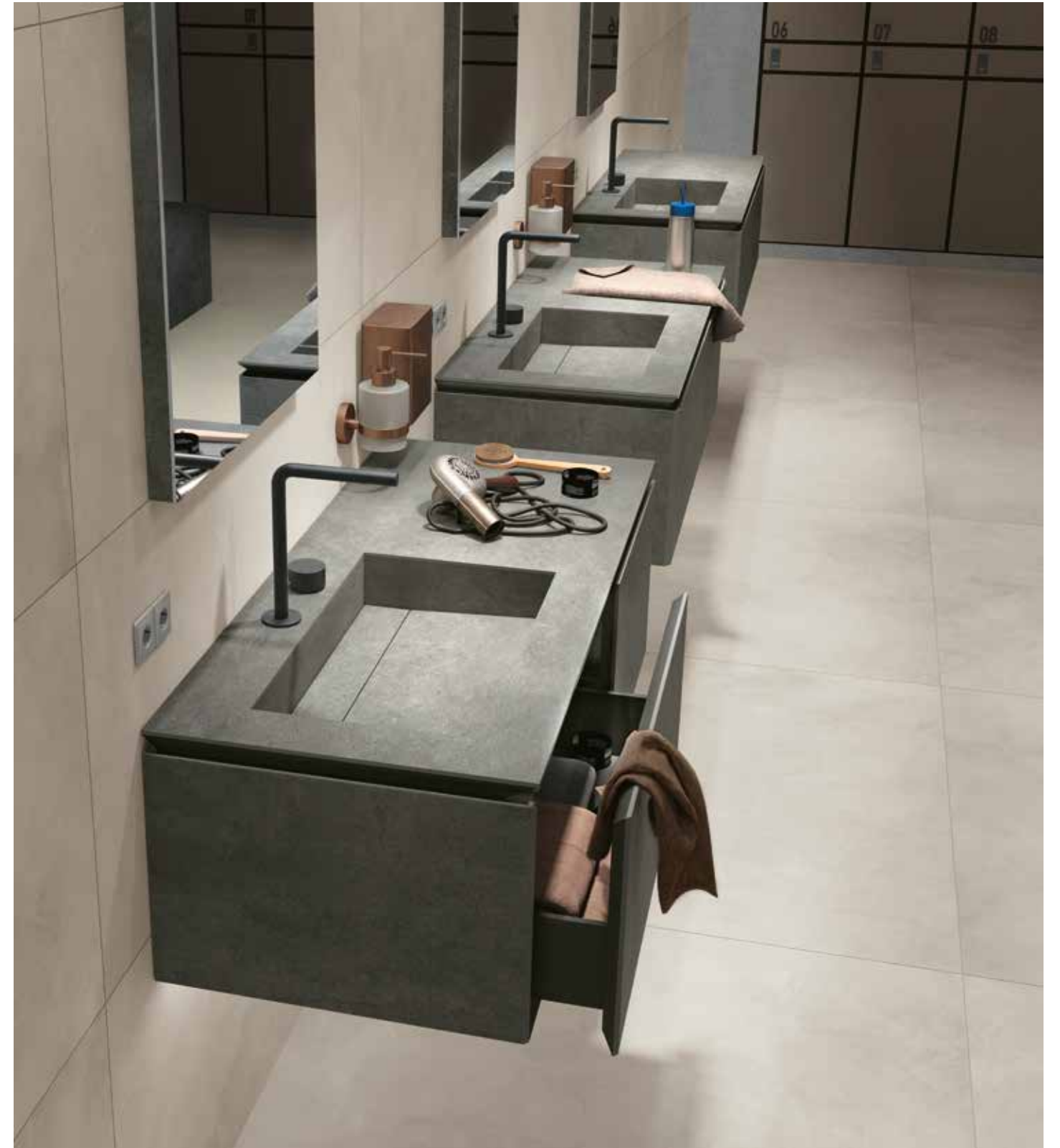

36

37

FINITURE IMMAGINE | PICTURE FINISHES

- GLAMOUR > GLOCAL Classic GC 05 SP
- BLISS > GLOCAL Classic GC 05 SP
- STAY > GLOCAL Classic GC 05 SP
- Floor > CLAY Calm CL 01 SP SQ  
1200x1200 | 48"x48" ± 9 mm
- Wall > CLAY Calm CL 01 SP SQ  
600x1200 | 24"x48" ± 9 mm



# > GLAD

**Monoblocco con lavabo integrato**  
Vanity unit with built-in washbasin

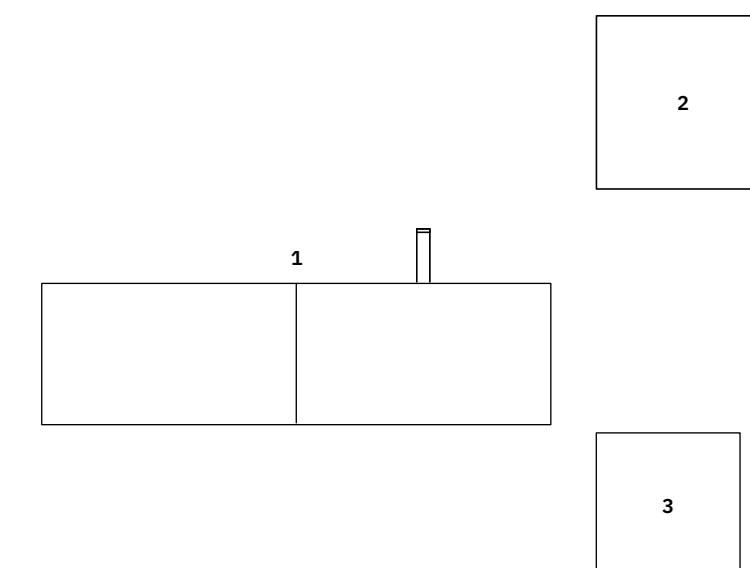
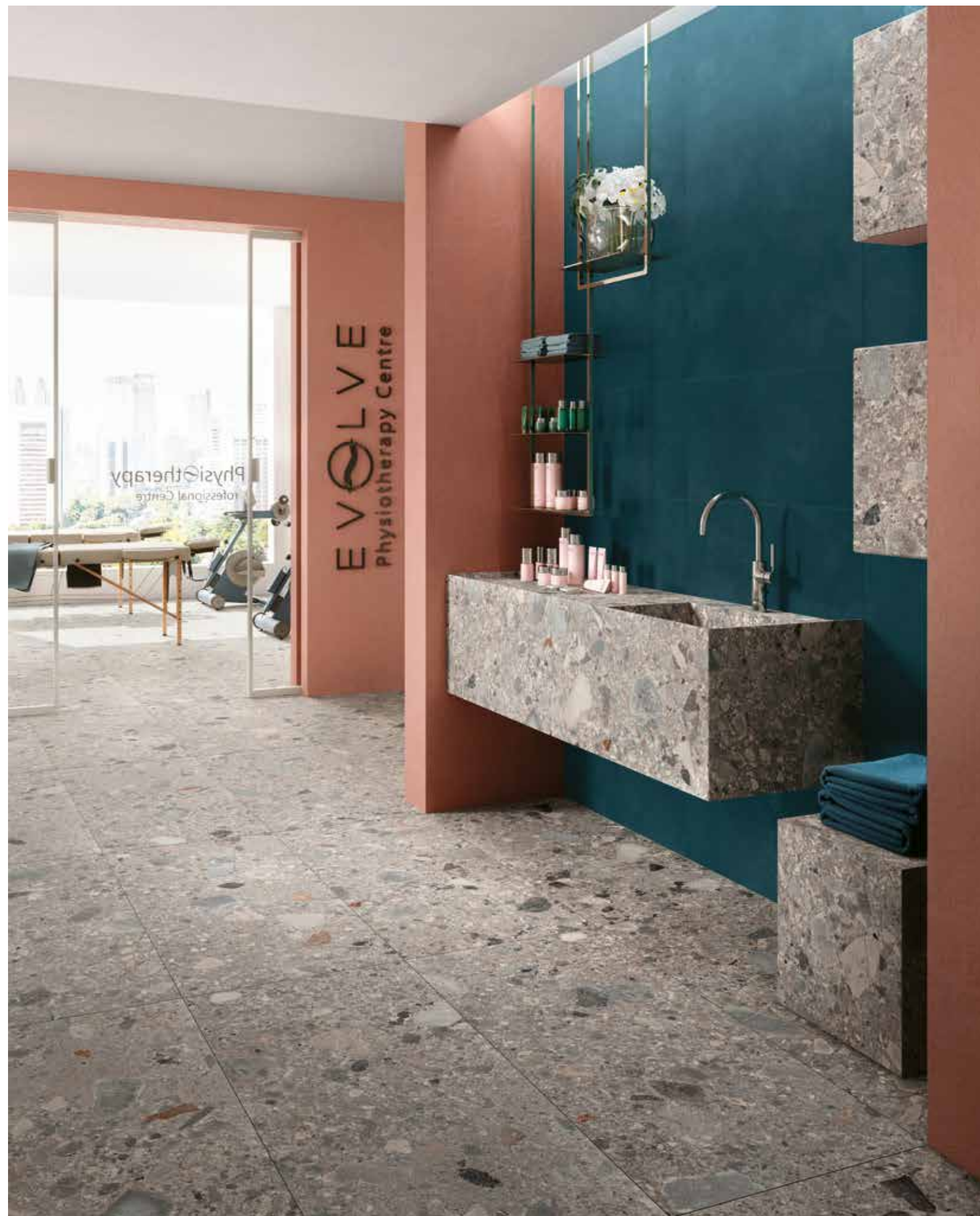

**FINITURE IMMAGINE | PICTURE FINISHES**

- 1 > GLAD GD120D**  
Gamma completa, dimensioni e finiture disponibili: pag. 82-83  
Complete range, sizes and available finishes: p. 82-83
- 2 > SMART SMR5052**  
Gamma completa, dimensioni e finiture disponibili: pag. 98  
Complete range, sizes and available finishes: p. 98
- 3 > STAY STQ40**  
Gamma completa, dimensioni e finiture disponibili: pag. 98  
Complete range, sizes and available finishes: p. 98



- 1 > NORR 2.0 Farge RR 05 NAT**
- 2 > NORR 2.0 Farge RR 05 NAT**
- 3 > NORR 2.0 Farge RR 05 NAT**

Ogni elemento della composizione può essere acquistato singolarmente o in abbinamento e personalizzato con i prodotti Mirage® indicati alle pagine 99-111.  
Each element of the composition can be purchased individually or to match, and can be produced with all the Mirage® products indicated on pages 99-111.





> **GLAD**

FINITURE IMMAGINE | PICTURE FINISHES

- GLAD > NORR 2.0 Farge RR 05 NAT
- Floor > NORR 2.0 Farge RR 05 NAT SQ  
600x1200 | 24"x48" ± 9 mm
- Wall > CLAY Karma CL 08 SP SQ  
400x800 | 16"x31½" ± 9 mm



# > EASE

Top scatolare in legno essenza quercia

Wooden box-shaped countertop

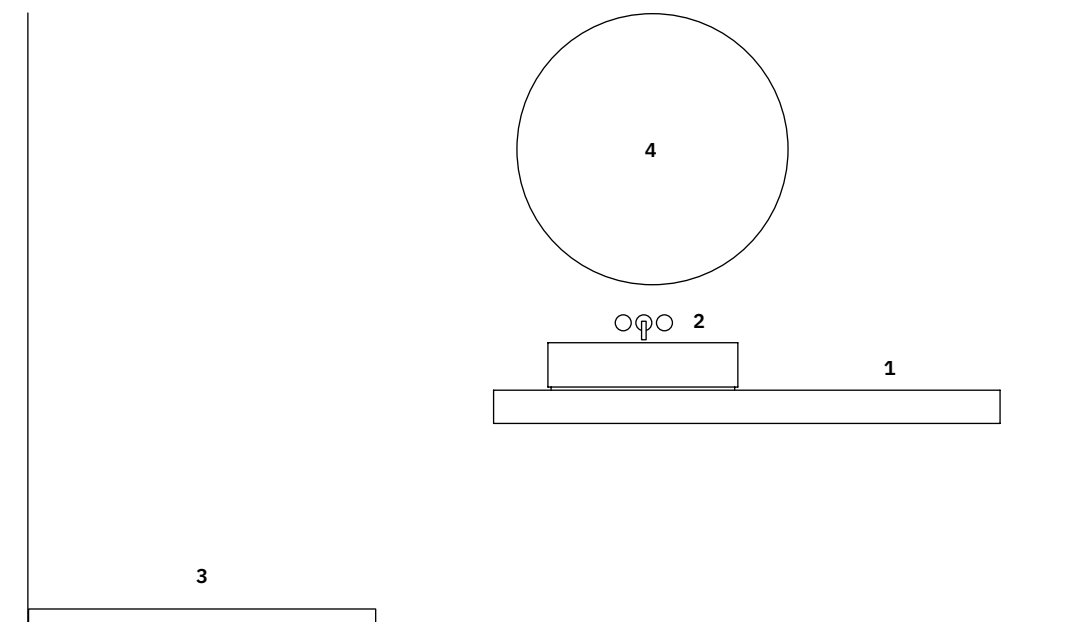

FINITURE IMMAGINE | PICTURE FINISHES

- 1 > **EASE ES150**  
Gamma completa, dimensioni e finiture disponibili: pag. 80  
Complete range, sizes and available finishes: p. 80
- 2 > **HAPPINESS HP60L**  
Gamma completa, dimensioni e finiture disponibili: pag. 86-87  
Complete range, sizes and available finishes: p. 86-87
- 3 > **APPEAL APR80120**  
Gamma completa, dimensioni e finiture disponibili: pag. 96  
Complete range, sizes and available finishes: p. 96
- 4 > **BLISS MRØ110**  
Gamma completa, dimensioni e finiture disponibili: pag. 94-95  
Complete range, sizes and available finishes: p. 94-95



1 > **Legno essenza quercia** | Oak wood finish



2 > **LEMMY Nimbus LY 02 SP**

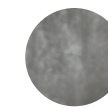

3 > **LEMMY King LY 09 SP**

Ogni elemento della composizione può essere acquistato singolarmente o in abbinamento e personalizzato con i prodotti Mirage® indicati alle pagine 99-111.  
Each element of the composition can be purchased individually or to match, and can be produced with all the Mirage® products indicated on pages 99-111.



> **EASE**

FINITURE IMMAGINE | PICTURE FINISHES

- EASE** > Oak wood finish
- HAPPINESS** > LEMMY Nimbus LY 02 SP
- APPEAL** > LEMMY King LY 09 SP
- Floor** > BLUE.S Ego Vintage BL 04 NAT NO SQ  
75x600 | 3"x24" ± 9 mm
- Wall** > LEMMY Nimbus LY 02 SP SQ  
1200x2780 | 48"x110" ± 6 mm



# > JOY

**Top scatolare con lavabo integrato e base indipendente**

Vanity top with integrated washbasin and separate base unit

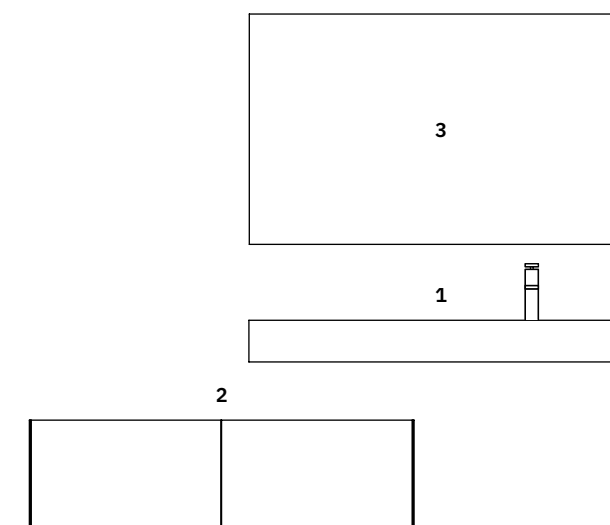

**FINITURE IMMAGINE | PICTURE FINISHES**

- 1 > JOY JY120TD**  
Gamma completa, dimensioni e finiture disponibili: pag. 88-89  
Complete range, sizes and available finishes: p. 88-89
- 2 > BASE JY120B**  
Gamma completa, dimensioni e finiture disponibili: pag. 88-89  
Complete range, sizes and available finishes: p. 88-89
- 3 > BLISS MR12072**  
Gamma completa, dimensioni e finiture disponibili: pag. 94-95  
Complete range, sizes and available finishes: p. 94-95



- 1 > JEWELS Statuario Venato JW 14 LUC**
- 2 > JEWELS Statuario Venato JW 14 LUC**
- 3 > JEWELS Statuario Venato JW 14 LUC**

Ogni elemento della composizione può essere acquistato singolarmente o in abbinamento e personalizzato con i prodotti Mirage® indicati alle pagine 99-111.  
Each element of the composition can be purchased individually or to match, and can be produced with all the Mirage® products indicated on pages 99-111.



> **JOY**

FINITURE IMMAGINE | PICTURE FINISHES

**JOY + BASE** > **JEWELS** Statuario Venato **JW 14** LUC

**BLISS** > **JEWELS** Statuario Venato **JW 14** LUC

**Floor** > **JURUPA** Master **JP 03** NAT SQ  
200x1200 | 8"x48" ± 9 mm

**Wall** > **GLOCAL** Ideal **GC 03** SP SQ  
1200x2780 | 48"x110" ± 6 mm



> JOY





52

> JOY

FINITURE IMMAGINE | PICTURE FINISHES

- JOY + BASE > LEMMY Excalibur LY 03 SP
- BLISS > LEMMY Excalibur LY 03 SP
- Floor > LEMMY Excalibur LY 03 SP SQ  
1200x1200 | 48"x48" ± 9 mm
- Wall > LEMMY Palladium LY 01 SP SQ  
1200x2780 | 48"x110" ± 6 mm



53



# > FREEDOM

**Monoblocco con lavabo integrato**

Vanity unit with built-in washbasin

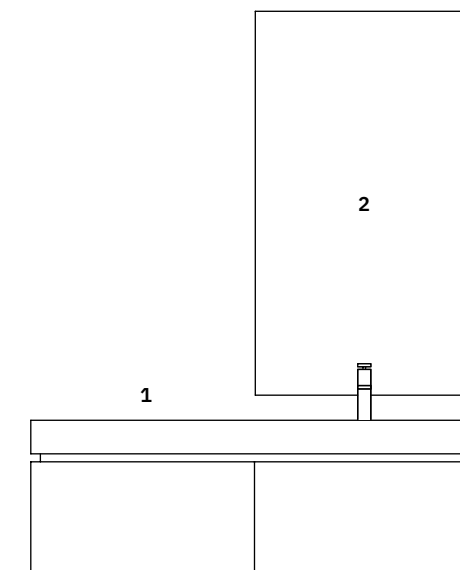

**FINITURE IMMAGINE | PICTURE FINISHES**

**1 > FREEDOM FR140D**

**Gamma completa, dimensioni e finiture disponibili: pag. 81**  
Complete range, sizes and available finishes: p. 81

**2 > BLISS MR6090**

**Gamma completa, dimensioni e finiture disponibili: pag. 94-95**  
Complete range, sizes and available finishes: p. 94-95

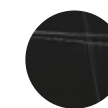

**1 > JEWELS Moonless JW 17 LUC**

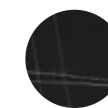

**2 > JEWELS Moonless JW 17 LUC**

Ogni elemento della composizione può essere acquistato singolarmente o in abbinamento e personalizzato con i prodotti Mirage® indicati alle pagine 99-111.  
Each element of the composition can be purchased individually or to match, and can be produced with all the Mirage® products indicated on pages 99-111.



56



57

> **FREEDOM**

FINITURE IMMAGINE | PICTURE FINISHES

**FREEDOM** > **JEWELS** Moonless JW 17 LUC

**BLISS** > **JEWELS** Moonless JW 17 LUC

**Floor** > **JURUPA** Master JP 03 NAT SQ  
200x1200 | 8"x48" ± 9 mm

**Wall** > **GLOCAL** Perfect GC 02 SP SQ  
1200x2780 | 48"x110" ± 6 mm





# > COMFORT

Lavabo ad appoggio freestanding  
Freestanding washbasin

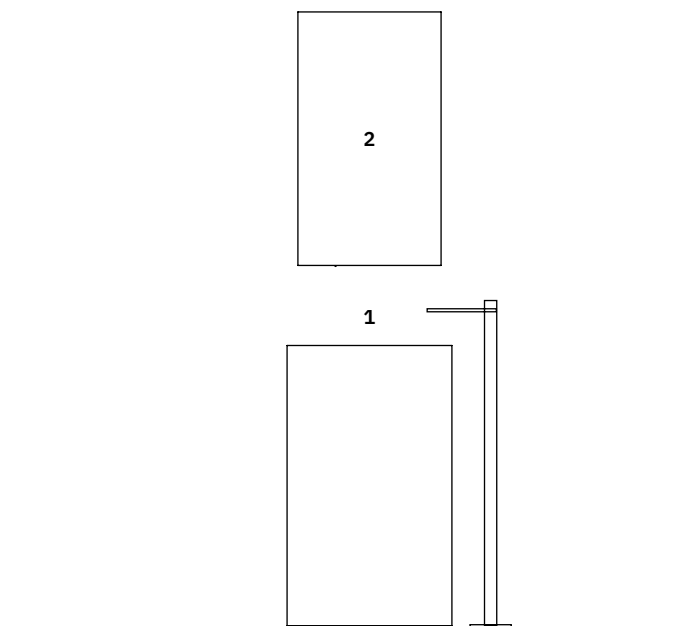

FINITURE IMMAGINE | PICTURE FINISHES

1 > **COMFORT** CF50  
Gamma completa, dimensioni e finiture disponibili: pag. 78  
Complete range, sizes and available finishes: p. 78

2 > **BLISS** MR4580  
Gamma completa, dimensioni e finiture disponibili: pag. 94-95  
Complete range, sizes and available finishes: p. 94-95



1 > **JEWELS** Raymi JW 16 LUC

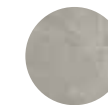

2 > **JEWELS** Raymi JW 16 LUC

Ogni elemento della composizione può essere acquistato singolarmente o in abbinamento e personalizzato con i prodotti Mirage® indicati alle pagine 99-111.  
Each element of the composition can be purchased individually or to match, and can be produced with all the Mirage® products indicated on pages 99-111.



60

> COMFORT

FINITURE IMMAGINE | PICTURE FINISHES

- COMFORT** > JEWELS Raymi JW 16 LUC
- BLISS** > JEWELS Raymi JW 16 LUC
- Floor** > HUB Compact UB 04 NAT SQ  
600x600 | 24"x24" ± 9 mm
- Wall** > JEWELS Raymi JW 16 LUC SQ  
1200x2780 | 48"x110" ± 6 mm

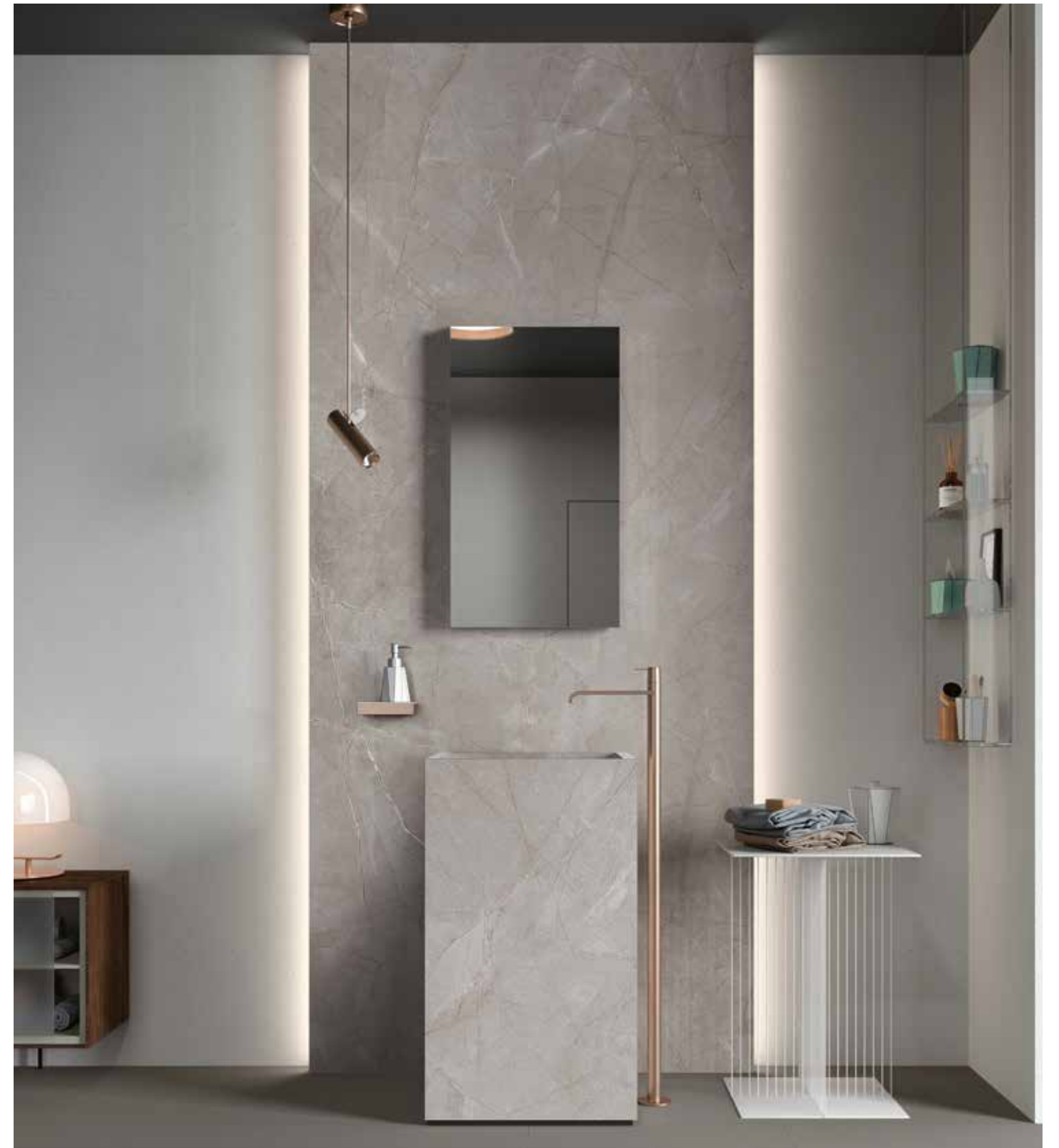

61



# > HAPPINESS

Top scatolare in gres, base e lavabo da appoggio

Box-shaped vanity top, base unit and washbasin

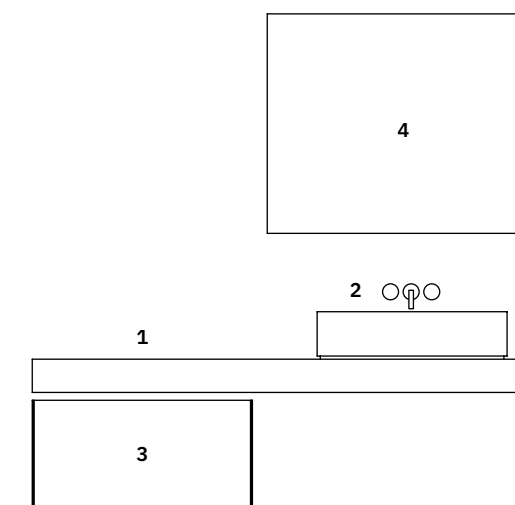

FINITURE IMMAGINE | PICTURE FINISHES

- 1 > **HAPPINESS HP140T**  
Gamma completa, dimensioni e finiture disponibili: pag. 86-87  
Complete range, sizes and available finishes: p. 86-87
- 2 > **HAPPINESS HP60L**  
Gamma completa, dimensioni e finiture disponibili: pag. 86-87  
Complete range, sizes and available finishes: p. 86-87
- 3 > **BASE JY70B**  
Gamma completa, dimensioni e finiture disponibili: pag. 86-87  
Complete range, sizes and available finishes: p. 86-87
- 4 > **BLISS MR9072**  
Gamma completa, dimensioni e finiture disponibili: pag. 94-95  
Complete range, sizes and available finishes: p. 94-95



1 > **NORR 2.0 Grå RR 02 NAT**



2 > **NORR 2.0 Grå RR 02 NAT**

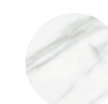

3 > **JEWELS Gioia White JW 13 LUC**



4 > **NORR 2.0 Grå RR 02 NAT**

Ogni elemento della composizione può essere acquistato singolarmente o in abbinamento e personalizzato con i prodotti Mirage® indicati alle pagine 99-111.  
Each element of the composition can be purchased individually or to match, and can be produced with all the Mirage® products indicated on pages 99-111.



> HAPPINESS

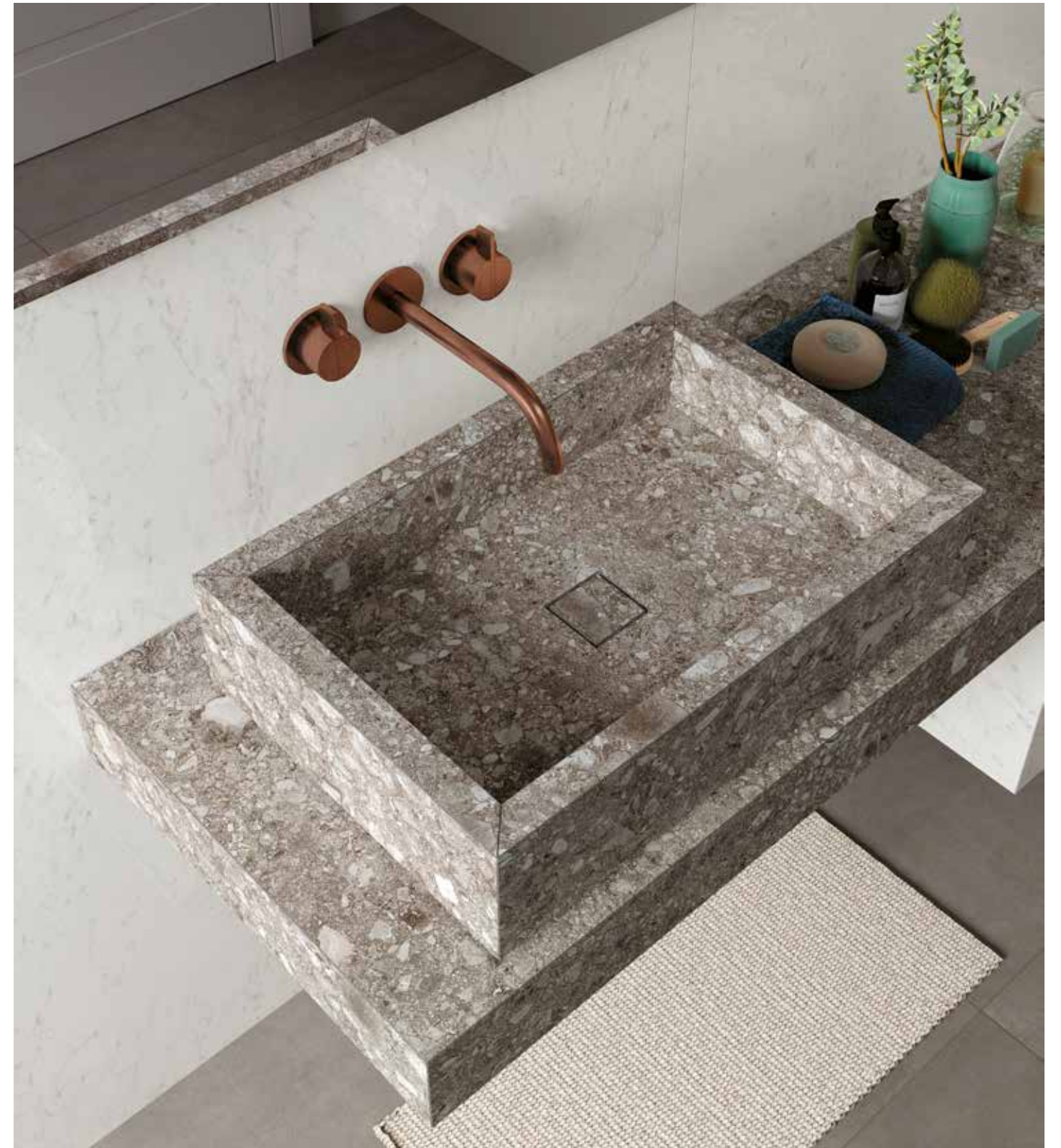

64

65

FINITURE IMMAGINE | PICTURE FINISHES

**HAPPINESS** > NORR 2.0 Grå RR 02 NAT

**BLISS** > NORR 2.0 Grå RR 02 NAT

**Floor** > GLOCAL Type GC 04 NAT SQ  
600x1200 | 24"x48" ± 9 mm

**Wall** > JEWELS Gioia White JW 13 LUC SQ  
1200x2780 | 48"x110" ± 6 mm



# > APPEAL

**Piatto doccia**  
Shower tray

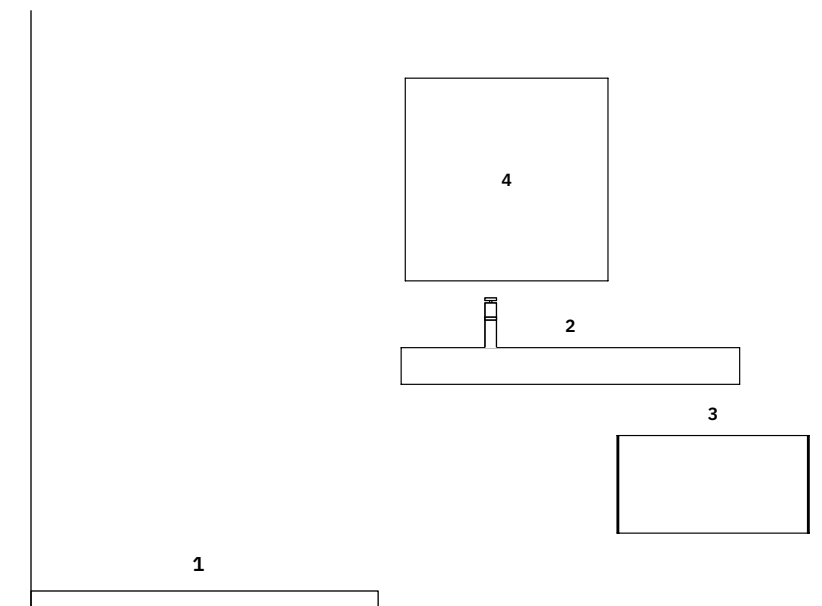

**FINITURE IMMAGINE | PICTURE FINISHES**



1 > **GLOCAL** Ideal **GC 03 SP**

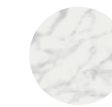

2 > **JEWELS** Statuario Lunensis **JW 12 LUC**



3 > **JEWELS** Statuario Lunensis **JW 12 LUC**



4 > **JEWELS** Statuario Lunensis **JW 12 LUC**

1 > **APPEAL** APR90120  
Gamma completa, dimensioni e finiture disponibili: pag. 96  
Complete range, sizes and available finishes: p. 96

2 > **JOY** JY120TS  
Gamma completa, dimensioni e finiture disponibili: pag. 88-89  
Complete range, sizes and available finishes: p. 88-89

3 > **BASE** JY70B  
Gamma completa, dimensioni e finiture disponibili: pag. 88-89  
Complete range, sizes and available finishes: p. 88-89

4 > **BLISS** MR7072  
Gamma completa, dimensioni e finiture disponibili: pag. 94-95  
Complete range, sizes and available finishes: p. 94-95

Ogni elemento della composizione può essere acquistato singolarmente o in abbinamento e personalizzato con i prodotti Mirage® indicati alle pagine 99-111.  
Each element of the composition can be purchased individually or to match, and can be produced with all the Mirage® products indicated on pages 99-111.





# > BALANCE

Colonna con frontale in gres porcellanato e ripiani in cristallo

Column with front panel in porcelain stoneware and glass shelves

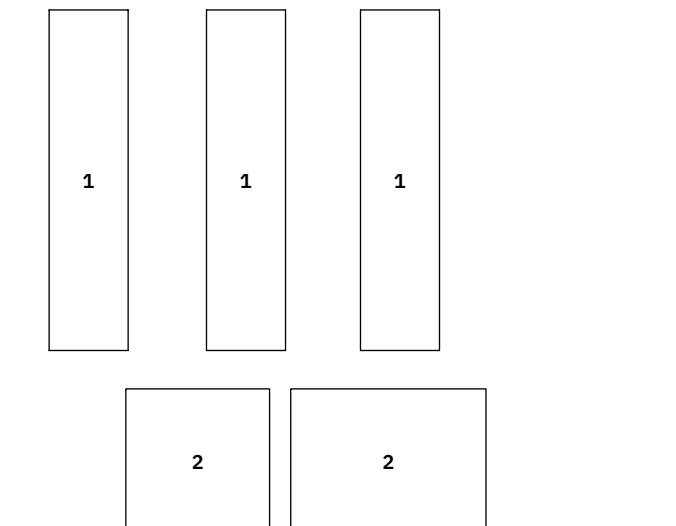

1 > **BALANCE** BLR35160  
Gamma completa, dimensioni e finiture disponibili: pag. 97  
Complete range, sizes and available finishes: p. 97

2 > **STAY** STR6090  
**STAY** STQ60  
Gamma completa, dimensioni e finiture disponibili: pag. 98  
Complete range, sizes and available finishes: p. 98

**FINITURE IMMAGINE | PICTURE FINISHES**



1 > **COSMOPOLITAN** Arabescato Oro CP 03 LUC

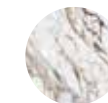

2 > **COSMOPOLITAN** Arabescato Oro CP 03 LUC

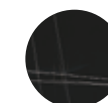

2 > **JEWELS** Moonless JW 17 LUC

Ogni elemento della composizione può essere acquistato singolarmente o in abbinamento e personalizzato con i prodotti Mirage® indicati alle pagine 99-111.  
Each element of the composition can be purchased individually or to match, and can be produced with all the Mirage® products indicated on pages 99-111.



> BALANCE

70

71

FINITURE IMMAGINE | PICTURE FINISHES

BALANCE > COSMOPOLITAN Arabescato Oro CP 03 LUC

STAY > COSMOPOLITAN Arabescato Oro CP 03 LUC  
JEWELS Moonless JW 17 LUC

Floor > LAGOON Moonbeam LG 01 NAT SQ  
1200x1200 | 48"x48" | 9 mm





# > STAY

Seduta con ruote

Seat with wheels

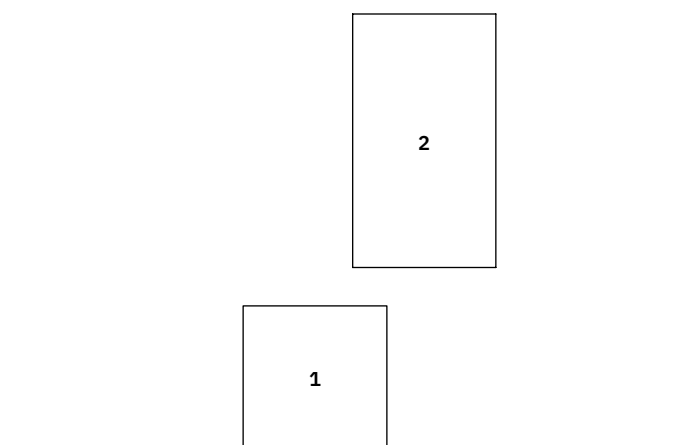

**FINITURE IMMAGINE | PICTURE FINISHES**

- 1 > **STAY STR6090**  
Gamma completa, dimensioni e finiture disponibili: pag. 98  
Complete range, sizes and available finishes: p. 98
- 2 > **BLISS MR6090**  
Gamma completa, dimensioni e finiture disponibili: pag. 94-95  
Complete range, sizes and available finishes: p. 94-95



- 1 > **LEMMY King LY 09 SP**
- 2 > **NORR 2.0 Grå Fine RR 12 NAT**

Ogni elemento della composizione può essere acquistato singolarmente o in abbinamento e personalizzato con i prodotti Mirage® indicati alle pagine 99-111.  
Each element of the composition can be purchased individually or to match, and can be produced with all the Mirage® products indicated on pages 99-111.





74

> **STAY**

FINITURE IMMAGINE | PICTURE FINISHES

- STAY > LEMMY King LY 09 SP
- BLISS > NORR 2.0 Grå Fine RR 12 NAT
- Floor > NORR 2.0 Grå Fine RR 12 NAT SQ  
1200x1200 | 48"x48" ± 9 mm
- Wall > LEMMY Pumpkin LY 08 SP SQ  
600x1200 | 24"x48" ± 9 mm



75

# > TECHNICAL DETAILS

CONFIGURAZIONI | FEATURES

SUPERFICI | FINISHES

FINITURE | PRODUCTS

IMBALLI | PACKAGING

CARATTERISTICHE TECNICHE | TECHNICAL SPECIFICATIONS

## LETTURA CODICE PRODOTTO | PRODUCT CODE READING

### JYD160T

**JY** > **COMPOSIZIONE JOY**  
JOY COMPOSITION

**D** > **LAVABO DOPPIO (il singolo non ha indicazioni)**  
DOUBLE WASHBASIN (the version with single washbasin  
is expressed without the D letter in it's code)

**160** > **LARGHEZZA IN CM**  
CM WIDTH

**T** > **TIPOLOGIA PRODOTTO - TOP**  
PRODUCT TYPE - TOP

## NOTE

Ogni elemento della composizione può essere acquistato singolarmente o in abbinamento, e realizzato con i prodotti indicati alle pagine 99-111. Tutti i mobili sono forniti di idonei agganci. Non sono invece inclusi nella fornitura agganci chimici e accessori (rubinetteria, miscelatori).

Each element of the composition can be purchased individually or to match, and is made with the products indicated on pages 99-111. All furniture items are supplied with the appropriate hardware necessary for mounting. Resin-injected fittings and accessories (taps, mixer taps), are not included.

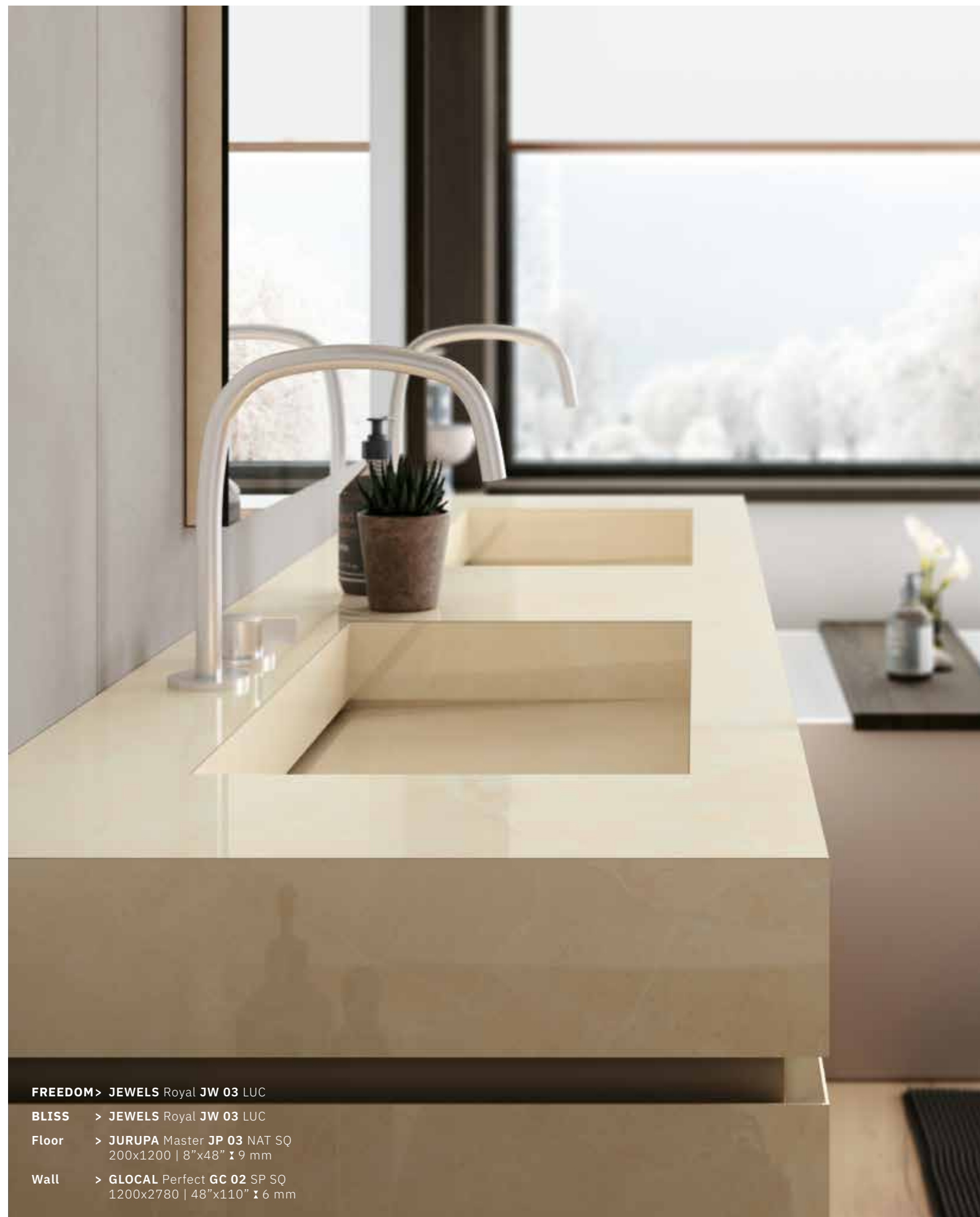

**FREEDOM** > **JEWELS** Royal JW 03 LUC  
**BLISS** > **JEWELS** Royal JW 03 LUC  
**Floor** > **JURUPA** Master JP 03 NAT SQ  
200x1200 | 8"x48" x 9 mm  
**Wall** > **GLOCAL** Perfect GC 02 SP SQ  
1200x2780 | 48"x110" x 6 mm



# > COMFORT

Lavabo ad appoggio freestanding  
Freestanding washbasin



Lavabo ad appoggio freestanding.

Free-standing washbasin.

Freistehendes Auflagebecken.

Lavabo d'appui sur pied.

独立台面式洗手盆。

## LAVABO DA TERRA | FLOOR-STANDING WASHBASIN

cod. CF50

Scarico a terra  
Floor drain

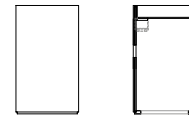
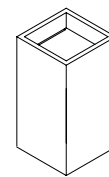

cod. CF50

Scarico a muro  
Wall drain

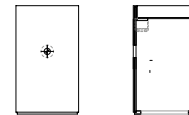
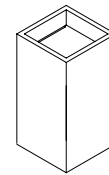

cod.	L (cm)	P (cm)	H (cm)	price
CF50	50 20"	50 20"	87 34,3"	C2

DIMENSIONE INTERNA LAVABO WASHBASIN INTERNAL DIMENSION	43 17"	43 17"	11,3 max 4,4" max
---	-----------	-----------	----------------------

### NOTE

Ogni elemento della composizione può essere acquistato singolarmente o in abbinamento e personalizzato con i prodotti Mirage® indicati alle pagine 99-111. Tutti i mobili sono forniti di idonei agganci. Non sono invece inclusi nella fornitura agganci chimici e accessori (rubinetteria, miscelatori).

Contattare l'ufficio Engineering per informazioni sull'ancoraggio degli elementi.

Each element of the composition can be purchased individually or to match, and can be produced with all the Mirage® products indicated on pages 99-111.

All furniture items are supplied with the appropriate hardware necessary for mounting.

Resin-injected fittings and accessories (taps, mixer taps), are not included.

For further details on elements' anchoring please contact Mirage Engineering Division.

## Bathmood

# > DELIGHT

Lavabo ad appoggio freestanding  
Freestanding washbasin



## LAVABO DA TERRA | FLOOR-STANDING WASHBASIN

cod. DLQ50L | DLQ50G | DLQ50R

Scarico a terra  
Floor drain

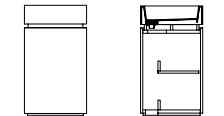
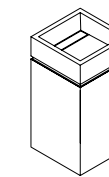

cod. DLQ50L | DLQ50G | DLQ50R

Scarico a muro  
Wall drain

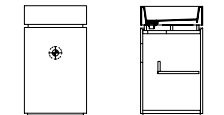
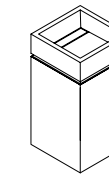

Lavabo ad appoggio freestanding, vano interno con ripiano ed apertura tramite anta DX/SX.

Finiture mobile: gres porcellanato, rovere termotrattato, laccatura su scala RAL o NCS

Freestanding washbasin, internal compartment with shelf and right/left side door opening.

Unit finishes: porcelain stoneware, heat-treated oak, lacquering in RAL or NCS colours.

Freistehendes Aufsatzwaschbecken, Innenraum mit Fach und Öffnung mit rechter/linker Tür.

Möbelausfertigungen: Feinsteinzeug, wärmebehandelte Eiche, Lackierung in RAL- oder NCS-Farben.

Lavabo autoportante, compartiment interne avec tablette et ouverture avec porte DX/SX.

Finitions mobiles : grès cérame, rouvre thermo traité, laquage suivant nuanciers RAL ou NCS.

独立式落地盥洗盆，内部隔间配有层板，通过右/左门板开启。

家具饰面：炆瓷，经过热处理的橡木，RAL或NCS色卡颜色的烤漆

cod.	L (cm)	P (cm)	H (cm)	price
DLQ50L Finitura laccata Lacquered finish	50 20"	50 20"	88 34,6"	C3

DLQ50G Finitura gres porcellanato Mirage Mirage porcelain stoneware finish	50 20"	50 20"	88 34,6"	C8
--	-----------	-----------	-------------	----

DLQ50R Finitura rovere termotrattato Heat-treated oak finish	50 20"	50 20"	88 34,6"	C6
--	-----------	-----------	-------------	----

DIMENSIONE INTERNA LAVABO WASHBASIN INTERNAL DIMENSION	43,6 17,1"	43,6 17,1"	-
---	---------------	---------------	---

### NOTE

Ogni elemento della composizione può essere acquistato singolarmente o in abbinamento e personalizzato con i prodotti Mirage® indicati alle pagine 99-111.

Tutti i mobili sono forniti di idonei agganci. Non sono invece inclusi nella fornitura agganci chimici e accessori (rubinetteria, miscelatori).

Contattare l'ufficio Engineering per informazioni sull'ancoraggio degli elementi.

Each element of the composition can be purchased individually or to match, and can be produced with all the Mirage® products indicated on pages 99-111.

All furniture items are supplied with the appropriate hardware necessary for mounting.

Resin-injected fittings and accessories (taps, mixer taps), are not included.

For further details on elements' anchoring please contact Mirage Engineering Division.

# > EASE

Top scatolare in legno essenza quercia  
Wooden box-shaped countertop



Top scatolare per lavabo da appoggio in legno essenza quercia.

Box-shaped countertop for oak wood countertop washbasin.

Rechteckige Platte für Aufsatzwaschbecken aus Eichenholz.

Plan vasque à caisson pour lavabo d'appui en essence de bois de chêne.

盒形盥洗盆台面，栎木台上盆。

## TOP | TOP

cod. ES70 | ES80 | ES90 | ES100 | ES110 | ES120 | ES130 | ES140 | ES150

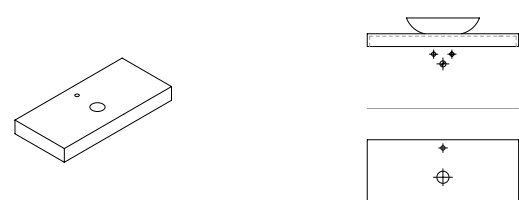

cod. ESD160 | ESD170 | ESD180 | ESD190 | ESD200

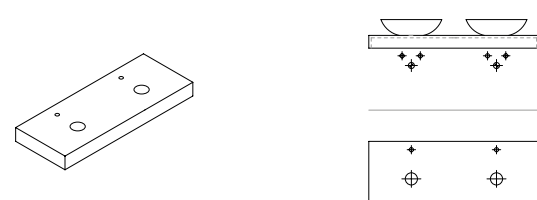

cod.	L (cm)	P (cm)	H (cm)	price
ES70	70 28"	51,5 20,3"	10,5 4,2"	A5
ES80	80 31,5"	51,5 20,3"	10,5 4,2"	A6
ES90	90 36"	51,5 20,3"	10,5 4,2"	A6
ES100	100 39,3"	51,5 20,3"	10,5 4,2"	A7
ES110	110 43,3"	51,5 20,3"	10,5 4,2"	A7
ES120	120 48"	51,5 20,3"	10,5 4,2"	A8
ES130	130 51,2"	51,5 20,3"	10,5 4,2"	A8
ES140	140 56"	51,5 20,3"	10,5 4,2"	A8
ES150	150 59"	51,5 20,3"	10,5 4,2"	A9
ESD160	160 64"	51,5 20,3"	10,5 4,2"	A9
ESD170	170 66,9"	51,5 20,3"	10,5 4,2"	B1
ESD180	180 72"	51,5 20,3"	10,5 4,2"	B1
ESD190	190 74,8"	51,5 20,3"	10,5 4,2"	B2
ESD200	200 78,6"	51,5 20,3"	10,5 4,2"	B2

### NOTE

Ogni elemento della composizione può essere acquistato singolarmente o in abbinamento e personalizzato con i prodotti Mirage® indicati alle pagine 99-111. Tutti i mobili sono forniti di idonei agganci. Non sono invece inclusi nella fornitura agganci chimici e accessori (rubinetteria, miscelatori). Contattare l'ufficio Engineering per informazioni sull'ancoraggio degli elementi.

Each element of the composition can be purchased individually or to match, and can be produced with all the Mirage® products indicated on pages 99-111. All furniture items are supplied with the appropriate hardware necessary for mounting. Resin-injected fittings and accessories (taps, mixer taps), are not included. For further details on elements' anchoring please contact Mirage Engineering Division.

## Bathmood

# > FREEDOM

Monoblocco con lavabo integrato  
Vanity unit with built-in washbasin



Monoblocco composto da porta lavabo con cassetto/i completo di top con lavabo integrato.

Vanity unit with drawer(s) with integrated washbasin.

Monoblock bestehend aus Waschbeckenunterbau mit Lade(n) mit integriertem Waschbecken.

Monobloc composé d'un porte-lavabo avec tiroir(s) complété par lavabo intégré.

一体式浴室柜，由带抽屉的基底和带嵌入式洗手盆的台面组合而成。

## MONOBLOCCO | MONOBLOCK

cod. FR90

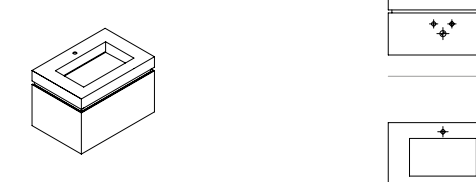

cod. FR120S | FR140S

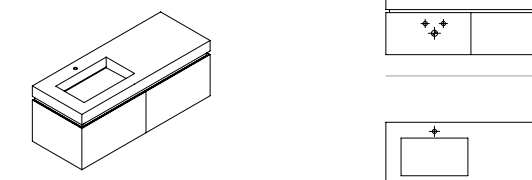

cod. FR120D | FR140D

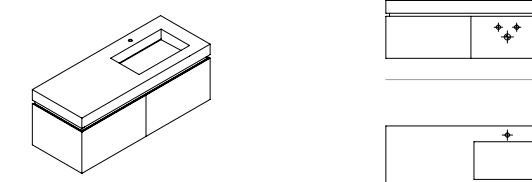

cod. FRD160

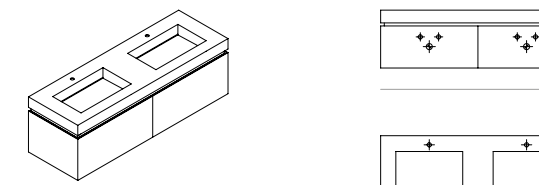

cod. FRD180

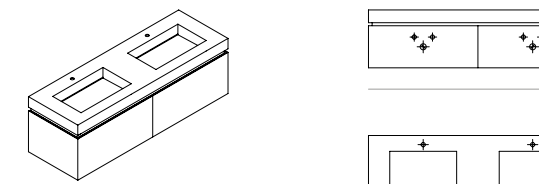

cod.	L (cm)	P (cm)	H (cm)	price
FR90	90 36"	51,5 20,3"	47,6 17,7"	C7
FR120S   FR120D	120 48"	51,5 20,3"	52 20,5"	D1
FR140S   FR140D	140 56"	51,5 20,3"	52 20,5"	D3
FRD160	160 64"	51,5 20,3"	52 20,5"	D7
FRD180	180 72"	51,5 20,3"	52 20,5"	D8
DIMENSIONE INTERNA LAVABO WASHBASIN INTERNAL DIMENSION	55 21,6"	31 12,2"	11,3 max 4,4" max	

### NOTE

Ogni elemento della composizione può essere acquistato singolarmente o in abbinamento e personalizzato con i prodotti Mirage® indicati alle pagine 99-111. Tutti i mobili sono forniti di idonei agganci. Non sono invece inclusi nella fornitura agganci chimici e accessori (rubinetteria, miscelatori). Contattare l'ufficio Engineering per informazioni sull'ancoraggio degli elementi.

Each element of the composition can be purchased individually or to match, and can be produced with all the Mirage® products indicated on pages 99-111. All furniture items are supplied with the appropriate hardware necessary for mounting. Resin-injected fittings and accessories (taps, mixer taps), are not included. For further details on elements' anchoring please contact Mirage Engineering Division.





**Monoblocco composto da porta lavabo con cassetto/i completo di top con lavabo integrato DX/SX. Base in acciaio INOX verniciato opzionale.**

Vanity unit composed of washbasin unit with drawer/s, complete with top with built-in washbasin on the right/left. Optional painted stainless steel base.

Monoblock bestehend aus Waschbeckenunterbau inklusive Platte mit integriertem Waschbecken (rechts/links). Basis aus lackiertem Edelstahl optional.

Monobloc composé d'un porte-lavabo avec tiroir/s comprenant un plan avec lavabo intégré DX/SX. Base en acier INOX verni en option.

一体式浴室柜，由带抽屉的盥洗盆柜和带右/左一体式盥洗盆的台面组合而成。可选不锈钢喷漆地柜。

cod.	L (cm)	P (cm)	H (cm)	price
GD90	90 36"	51,5 20,3"	44,6 17,5"	C6
GD120S	120 48"	51,5 20,3"	44,6 17,5"	C9
GD120D	120 48"	51,5 20,3"	44,6 17,5"	C9
GD140S	140 56"	51,5 20,3"	44,6 17,5"	D1
GD140D	140 56"	51,5 20,3"	44,6 17,5"	D1
GD160S	160 64"	51,5 20,3"	44,6 17,5"	D4
GD160D	160 64"	51,5 20,3"	44,6 17,5"	D4
<b>DIMENSIONE INTERNA LAVABO</b> WASHBASIN INTERNAL DIMENSION	55 21,6"	31 12,2"	-	

## MONOBLOCCO | MONOBLOCK

cod. GD90



cod. GD120S



cod. GD120D



cod. GD140S

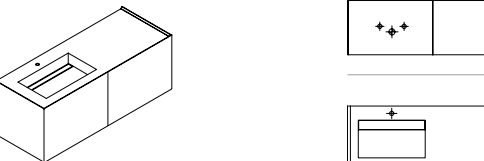

cod. GD140D

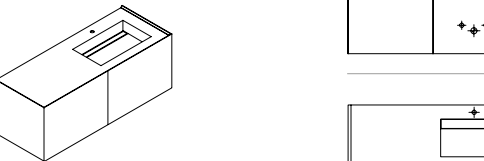

cod. GD160S

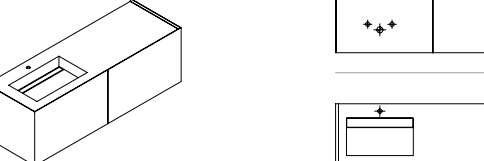

cod. GD160D

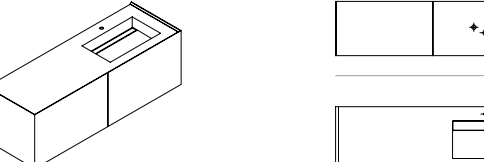

## STRUTTURA DI SUPPORTO IN ACCIAIO VERNICIATO OPZIONALE OPTIONAL STEEL BASE PAINTED

cod. GDS90



cod. GDS120



cod. GDS140



cod. GDS160

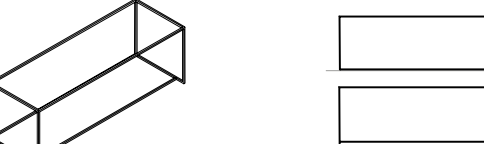

### BASE IN ACCIAIO INOX | PAINTED STAINLESS STEEL BASE

**Possibilità di fornitura di base colorata su richiesta, indicando il RAL di riferimento.**  
The base can be produced on request in further colors.

cod.	L (cm)	P (cm)	H (cm)	price
GDS90	90 36"	51,5 20,3"	45,4 17,8"	A9
GDS120	120 48"	51,5 20,3"	45,4 17,8"	B1
GDS140	140 56"	51,5 20,3"	45,4 17,8"	B2
GDS160	160 64"	51,5 20,3"	45,4 17,8"	B2

## ESEMPI DI COMPOSIZIONE | COMPOSITION EXAMPLES

cod. GD90 + GDS90

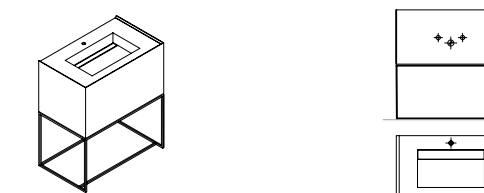

cod. GD160S + GDS160

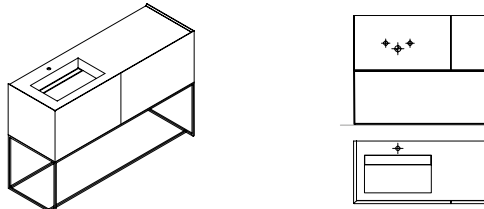

### NOTE

Ogni elemento della composizione può essere acquistato singolarmente o in abbinamento e personalizzato con i prodotti Mirage® indicati alle pagine 99-111. Tutti i mobili sono forniti di idonei agganci. Non sono invece inclusi nella fornitura agganci chimici e accessori (rubinetteria, miscelatori).  
Contattare l'ufficio Engineering per informazioni sull'ancoraggio degli elementi.

Each element of the composition can be purchased individually or to match, and can be produced with all the Mirage® products indicated on pages 99-111. All furniture items are supplied with the appropriate hardware necessary for mounting. Resin-injected fittings and accessories (taps, mixer taps), are not included. For further details on elements' anchoring please contact Mirage Engineering Division.

# > GLAMOUR

**Monoblocco con lavabo integrato**  
Vanity unit with built-in washbasin



**Monoblocco composto da porta lavabo con cassetto/i completo di top con lavabo integrato DX/SX.**

Vanity unit composed of washbasin unit with drawer/s, complete with top with built-in washbasin on the right/left.

Monoblock bestehend aus Waschbeckenunterbau mit Schublade(n) inklusive Platte mit integriertem Waschbecken (rechts/links).

Monobloc composé d'un porte-lavabo avec tiroir/s comprenant un plan avec lavabo intégré DX/SX.

一体式浴室柜，由带抽屉的盥洗盆柜和带右/左一体式盥洗盆的台面组合而成。

cod.	L (cm)	P (cm)	H (cm)	price
GM90	90 36"	51,5 20,3"	38,2 15"	C8
GM120S	120 48"	51,5 20,3"	38,2 15"	D2
GM120D	120 48"	51,5 20,3"	38,2 15"	D2
GM140S	140 56"	51,5 20,3"	38,2 15"	D4
GM140D	140 56"	51,5 20,3"	38,2 15"	D4
GM160S	160 64"	51,5 20,3"	38,2 15"	D6
GM160D	160 64"	51,5 20,3"	38,2 15"	D6
<b>DIMENSIONE INTERNA LAVABO</b> WASHBASIN INTERNAL DIMENSION	<b>55</b> 21,6"	<b>31</b> 12,2"	-	

## NOTE

Ogni elemento della composizione può essere acquistato singolarmente o in abbinamento e personalizzato con i prodotti Mirage® indicati alle pagine 99-111. Tutti i mobili sono forniti di idonei agganci. Non sono invece inclusi nella fornitura agganci chimici e accessori (rubinetteria, miscelatori). Contattare l'ufficio Engineering per informazioni sull'ancoraggio degli elementi.

## MONOBLOCCO | MONOBLOCK

cod. GM90

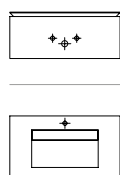
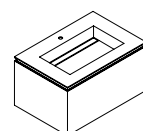

cod. GM120S

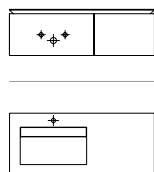
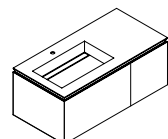

cod. GM120D

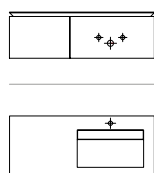
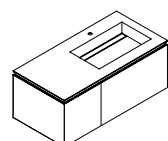

cod. GM140S

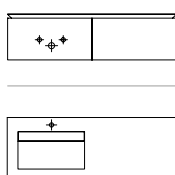
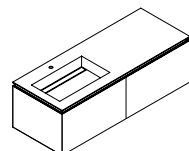

cod. GM140D

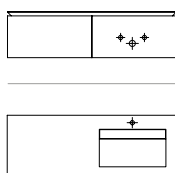
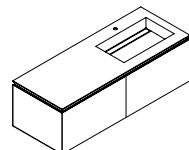

cod. GM160S

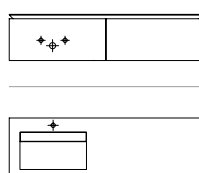
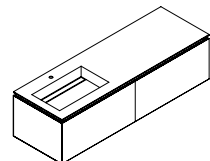

cod. GM160D

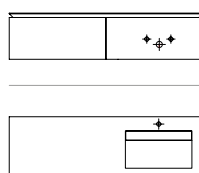
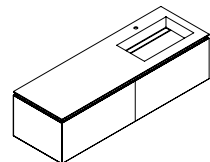

Each element of the composition can be purchased individually or to match, and can be produced with all the Mirage® products indicated on pages 99-111. All furniture items are supplied with the appropriate hardware necessary for mounting. Resin-injected fittings and accessories (taps, mixer taps), are not included. For further details on elements' anchoring please contact Mirage Engineering Division.

# Bathmood

# > GLEE

**Cassettiera sospesa con frontali rivestiti in gres porcellanato**  
Wall-hung drawer unit with front panels covered in porcelain stoneware



**Cassettiera sospesa con scocca laccata su scale RAL o NCS e frontali rivestiti in gres porcellanato.**

Wall-hung drawer unit with side panel in RAL or NCS colours and front panels covered in porcelain stoneware.

Hängekommode mit seitlichem, in RAL- oder NCS-Farben lackiertem Gehäuse und mit Feinsteinzeug verkleideten Vorderseiten.

Meuble de rangement suspendu avec structure laquée suivant nuanciers RAL ou NCS et façades revêtues en grès cérame.

壁挂式抽屉柜，配有RAL或NCS色卡颜色的烤漆柜体和炻瓷覆面前门板。

cod.	L (cm)	P (cm)	H (cm)	price
GE70	70 28"	51,5 20,3"	32 12,6"	B4
GE90	90 36"	51,5 20,3"	32 12,6"	B6
GE120	120 48"	51,5 20,3"	32 12,6"	B9
GE140	140 56"	51,5 20,3"	32 12,6"	C1
GE160	160 64"	51,5 20,3"	32 12,6"	C2
GE180	180 72"	51,5 20,3"	32 12,6"	C4

## NOTE

Ogni elemento della composizione può essere acquistato singolarmente o in abbinamento e personalizzato con i prodotti Mirage® indicati alle pagine 99-111. Tutti i mobili sono forniti di idonei agganci. Non sono invece inclusi nella fornitura agganci chimici e accessori (rubinetteria, miscelatori). Contattare l'ufficio Engineering per informazioni sull'ancoraggio degli elementi.

Each element of the composition can be purchased individually or to match, and can be produced with all the Mirage® products indicated on pages 99-111. All furniture items are supplied with the appropriate hardware necessary for mounting. Resin-injected fittings and accessories (taps, mixer taps), are not included. For further details on elements' anchoring please contact Mirage Engineering Division.

## CASSETTIERA SOSPESA | WALL-HUNG DRAWER

cod. GE70 | GE90

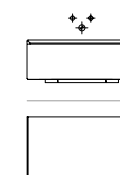
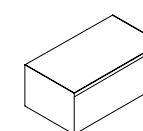

cod. GE120 | GE140 | GE160 | GE180

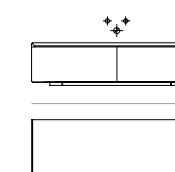
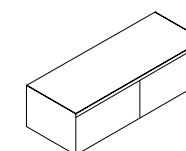

## ESEMPI DI COMPOSIZIONE | COMPOSITION EXAMPLES

cod. JY90T + GE90

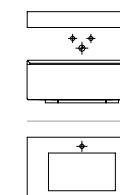
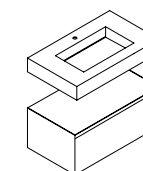

cod. JYD160T + GE160

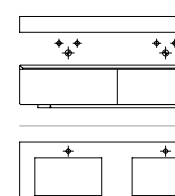
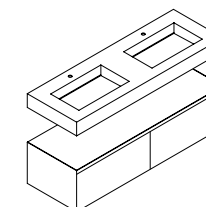

cod. HP90T + HP60L + GE90

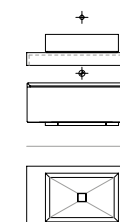
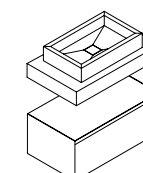

cod. HPD180T + 2 x HP60L + GE180

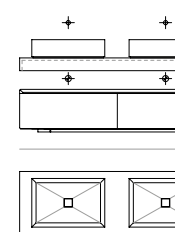
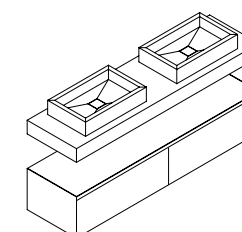



# > HAPPINESS

Top scatolare in gres, base e lavabo da appoggio  
Box-shaped vanity top, base unit and washbasin



Top scatolare in gres completo di foro per lavabo da appoggio, base con uno o due cassetti e lavabo da appoggio.

Box-shaped vanity top, complete with hole for washbasin, base unit with one or two drawers and washbasin.

Rechteckige Badplatte aus Feinsteinzeug mit Loch für Auflagebecken, Unterbau mit einer oder zwei Laden und Auflagebecken.

Plan vasque à caisson en grès complété d'un orifice pour lavabo d'appui, base avec un ou deux tiroirs et lavabo d'appui.

炻瓷材质的长方形台面备有用于台面式洗手盆的安装孔，带一个或两个抽屉的基底，和台面式洗手盆。

## LAVABO | WASHBASIN

cod. HP60L



## TOP | TOP

cod. HP90T | HP120T | HP140T

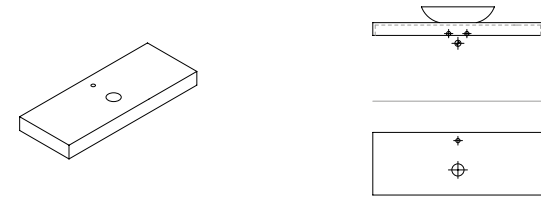

cod. HPD160T | HPD180T

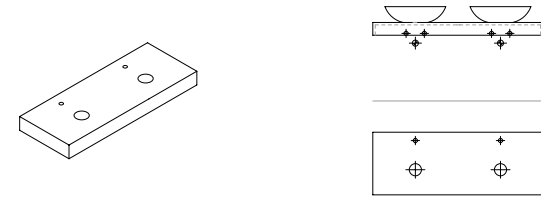

## BASE | BASE

cod. JY70B | JY90B



cod. JY120B | JY140B

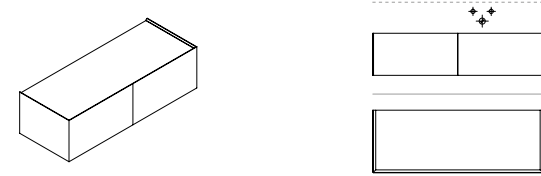

cod.	L (cm)	P (cm)	H (cm)	price
HP60L	60 24"	40 15,8"	12 4,8"	A9
HP90T	90 36"	51,5 20,3"	12 4,8"	B1
HP120T	120 48"	51,5 20,3"	12 4,8"	B3
HP140T	140 56"	51,5 20,3"	12 4,8"	B4
HPD160T	160 64"	51,5 20,3"	13 5,2"	B7
HPD180T	180 72"	51,5 20,3"	13 5,2"	B7
JY70B	70 28"	51,5 20,3"	34,6 13,7"	B3
JY90B	90 36"	51,5 20,3"	34,6 13,7"	B6
JY120B	120 48"	51,5 20,3"	34,6 13,7"	B8
JY140B	140 56"	51,5 20,3"	34,6 13,7"	B9
<b>DIMENSIONE INTERNA LAVABO</b> WASHBASIN INTERNAL DIMENSION	<b>53</b> 20,9"	<b>33</b> 13"	<b>11,3 max</b> 4,4" max	

## ESEMPI DI COMPOSIZIONE | COMPOSITION EXAMPLES

cod. HP90T | HP120T | HP140T + HP60L

rubinetto su top  
top-mounted tap

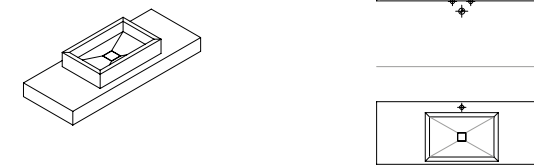

cod. HP90T | HP120T | HP140T + HP60L

rubinetto a parete  
wall-mounted tap

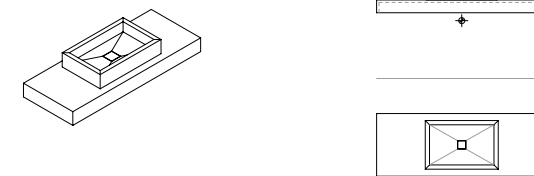

cod. HPD160T | HPD180T + 2 x HP60L

rubinetto su top  
top-mounted tap

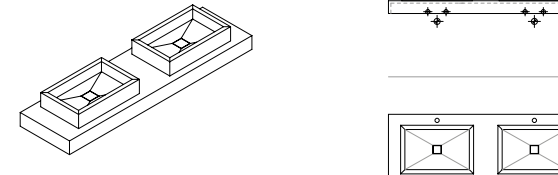

cod. HPD160T | HPD180T + 2 x HP60L

rubinetto a parete  
wall-mounted tap

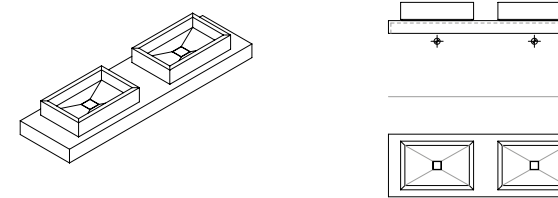

## ESEMPI DI COMPOSIZIONE | COMPOSITION EXAMPLES

cod. HPD180T + HP60L + JY70B

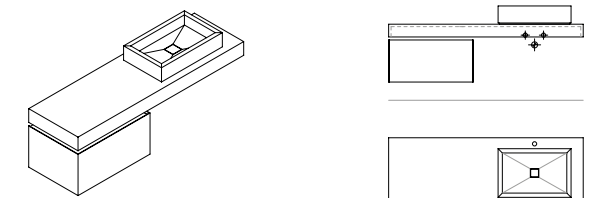

### NOTE

Ogni elemento della composizione può essere acquistato singolarmente o in abbinamento e personalizzato con i prodotti Mirage® indicati alle pagine 99-111. Tutti i mobili sono forniti di idonei agganci. Non sono invece inclusi nella fornitura agganci chimici e accessori (rubinetteria, miscelatori). Contattare l'ufficio Engineering per informazioni sull'ancoraggio degli elementi.

Each element of the composition can be purchased individually or to match, and can be produced with all the Mirage® products indicated on pages 99-111. All furniture items are supplied with the appropriate hardware necessary for mounting. Resin-injected fittings and accessories (taps, mixer taps), are not included. For further details on elements' anchoring please contact Mirage Engineering Division.

**Top scatolare con lavabo integrato e base indipendente**  
Vanity top with integrated washbasin and separate base unit



**Top scatolare con lavabo integrato (scarico a scomparsa) e base indipendente con cassetto.**

Vanity top with integrated washbasin (concealed drain) and separate base unit with drawer.

Rechteckige Badplatte mit integriertem Waschbecken (verdeckter Abfluss) und unabhängigem Unterbau mit Lade.

Plan vasque à caisson avec lavabo intégré (évacuation escamotable) et base indépendante avec tiroir.

珩瓷材质的长方形台面带嵌入式洗手盆(隐藏排水管)和带抽屉的独立基底。

cod.	L (cm)	P (cm)	H (cm)	price
JY90T	90 36"	51,5 20,3"	13 5,2"	B6
JY120TC   JY120TS   JY120TD	120 48"	51,5 20,3"	13 5,2"	B6
JY140TC   JY140TS   JY140TD	140 56"	51,5 20,3"	13 5,2"	B8
JY160T	160 64"	51,5 20,3"	13 5,2"	B8
JYD160T	160 64"	51,5 20,3"	13 5,2"	C4
JYD180T	180 72"	51,5 20,3"	13 5,2"	C5
JY70B	70 28"	51,5 20,3"	34,6 13,7"	B3
JY90B	90 36"	51,5 20,3"	34,6 13,7"	B6
JY120B	120 48"	51,5 20,3"	34,6 13,7"	B8
JY140B	140 56"	51,5 20,3"	34,6 13,7"	B9
JY160B	160 64"	51,5 20,3"	34,6 13,7"	C2
JY180B	180 72"	51,5 20,3"	34,6 13,7"	C3
<b>DIMENSIONE INTERNA LAVABO</b> WASHBASIN INTERNAL DIMENSION	<b>55</b> 21,6"	<b>31</b> 12,2"	<b>11,3 max</b> 4,4" max	

### TOP | TOP

cod. JY90T

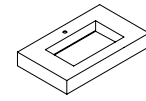

cod. JY120TC

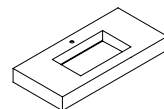

cod. JY120TS

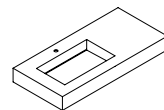

cod. JY120TD

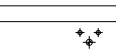
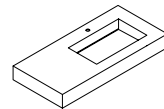

cod. JY140TC

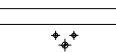
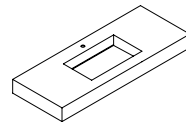

cod. JY140TS

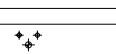
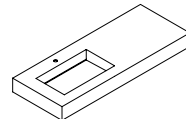

cod. JY140TD

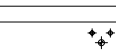
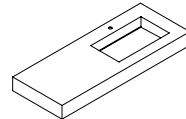

cod. JY160T

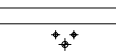
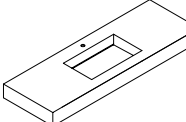

### TOP DOPPIO LAVABO | TOP WITH DOUBLE WASHBASIN

cod. JYD160T

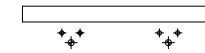
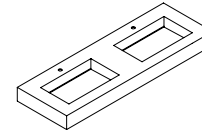

cod. JYD180T

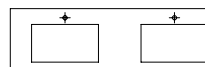
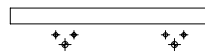
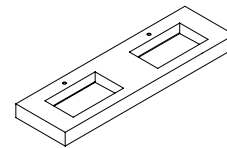

### ESEMPI DI COMPOSIZIONE | COMPOSITION EXAMPLES

cod. JY90T + JY90B

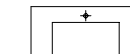
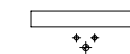
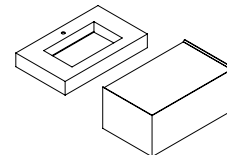

cod. JY120TC + JY120B

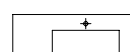
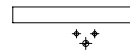
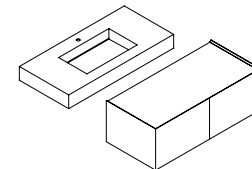

cod. JY120TS + JY120B

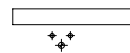
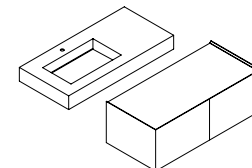

cod. JY120TD + JY120B

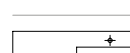
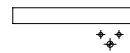
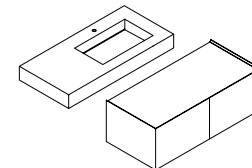

### BASE | BASE

cod. JY70B | JY90B

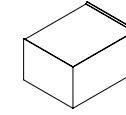

cod. JY120B | JY140B | JY160B | JY180B

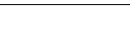
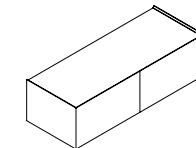

### ESEMPI DI COMPOSIZIONE | COMPOSITION EXAMPLES

cod. JY140TC + JY140B

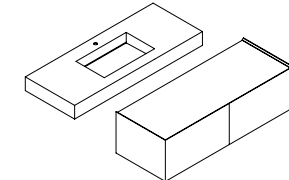

cod. JY140TS + JY140B

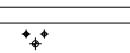
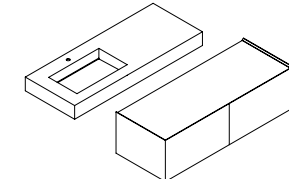

cod. JY140TD + JY140B

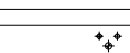
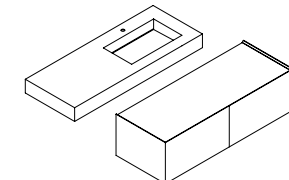

#### NOTE

Ogni elemento della composizione può essere acquistato singolarmente o in abbinamento e personalizzato con i prodotti Mirage® indicati alle pagine 99-111. Tutti i mobili sono forniti di idonei agganci. Non sono invece inclusi nella fornitura agganci chimici e accessori (rubinetteria, miscelatori).

Contattare l'ufficio Engineering per informazioni sull'ancoraggio degli elementi.

Each element of the composition can be purchased individually or to match, and can be produced with all the Mirage® products indicated on pages 99-111.

All furniture items are supplied with the appropriate hardware necessary for mounting. Resin-injected fittings and accessories (taps, mixer taps), are not included.

For further details on elements' anchoring please contact Mirage Engineering Division.



# > WISH

## Top scatolare con lavabo singolo integrato

Box-shaped countertop with built-in single washbasin



**Top scatolare con lavabo singolo integrato (con foro rubinetto) e piano in appoggio laterale DX/SX. Scarico con dogia removibile e possibilità di realizzazione con mix di finiture differenti.**

Box-shaped countertop with built-in single washbasin (with tap hole) and right/left side supporting surface. Drain with removable cover and option to combine different finishes.

Rechteckige Platte mit integriertem Einzelwaschbecken (mit Wasserhahnloch) und seitlicher Ablage (rechts/links). Abfluss mit abnehmbarer Leiste und Möglichkeit der Umsetzung mit einer Mischung aus verschiedenen Ausführungen.

Plan vasque à caisson avec lavabo simple intégré (avec trou robinet) et plan d'appui latéral DX/SX. Évacuation avec latte amovible et possibilité de réalisation avec un mélange de finitions différentes.

盒形盥洗盆台面，配有一体式单盆（有水龙头孔）和右/左侧置物平台。排水口带可拆卸板条，可通过混合不同的饰面而制作。

cod.	L (cm)	P (cm)	H (cm)	price
WH90S	90 36"	51,5 20,3"	25 10"	B8
WH90D	90 36"	51,5 20,3"	25 10"	B8
<b>DIMENSIONE INTERNA LAVABO</b> WASHBASIN INTERNAL DIMENSION	<b>50,4</b> 19,8"	<b>36,9</b> 14,5"	-	
WH120S	120 48"	51,5 20,3"	25 10"	B9
WH120D	120 48"	51,5 20,3"	25 10"	B9
WH140S	140 56"	51,5 20,3"	25 10"	C2
WH140D	140 56"	51,5 20,3"	25 10"	C2
<b>DIMENSIONE INTERNA LAVABO</b> WASHBASIN INTERNAL DIMENSION	<b>65,4</b> 25,7"	<b>36,9</b> 14,5"	-	

## TOP | TOP

cod. WH90S

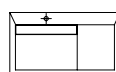
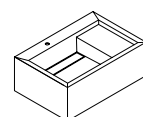

cod. WH90D

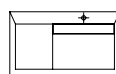
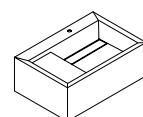

cod. WH120S

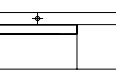
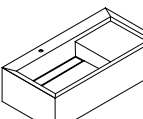

cod. WH120D

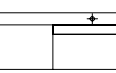
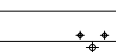
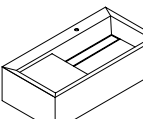

cod. WH140S

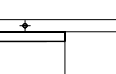
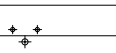
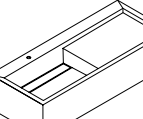

cod. WH140D

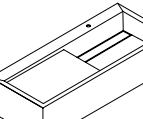

# Bathmood



**Top scatolare con lavabo singolo integrato (senza foro rubinetto) e piano in appoggio laterale DX/SX. Scarico con dogia removibile e possibilità di realizzazione con mix di finiture differenti.**

Box-shaped countertop with built-in single washbasin (without tap hole) and right/left side supporting surface. Drain with removable cover and option to combine different finishes.

Rechteckige Platte mit integriertem Einzelwaschbecken (ohne Wasserhahnloch) und seitlicher Ablage (rechts/links). Abfluss mit abnehmbarer Leiste und Möglichkeit der Umsetzung mit einer Mischung aus verschiedenen Ausführungen.

Plan vasque à caisson avec lavabo simple intégré (sans trou robinet) et plan d'appui latéral DX/SX. Évacuation avec latte amovible et possibilité de réalisation avec un mélange de finitions différentes.

盒形盥洗盆台面，配有一体式单盆（有水龙头孔）和右/左侧置物平台。排水口带可拆卸板条，可通过混合不同的饰面而制作。

cod.	L (cm)	P (cm)	H (cm)	price
WH90S	90 36"	51,5 20,3"	25 10"	B8
WH90D	90 36"	51,5 20,3"	25 10"	B8
<b>DIMENSIONE INTERNA LAVABO</b> WASHBASIN INTERNAL DIMENSION	<b>50,4</b> 19,8"	<b>42,3</b> 16,6"	-	
WH120S	120 48"	51,5 20,3"	25 10"	B9
WH120D	120 48"	51,5 20,3"	25 10"	B9
WH140S	140 56"	51,5 20,3"	25 10"	C2
WH140D	140 56"	51,5 20,3"	25 10"	C2
<b>DIMENSIONE INTERNA LAVABO</b> WASHBASIN INTERNAL DIMENSION	<b>65,4</b> 25,7"	<b>42,3</b> 16,6"	-	

## TOP | TOP

cod. WH90S

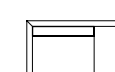
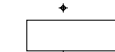
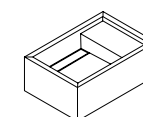

cod. WH90D

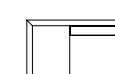
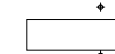
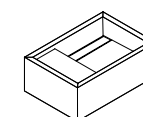

cod. WH120S

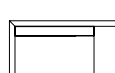
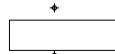
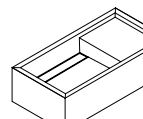

cod. WH120D

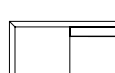
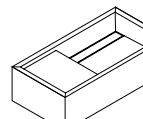

cod. WH140S

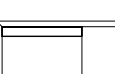
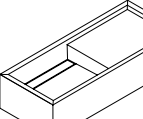

cod. WH140D

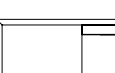
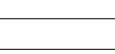
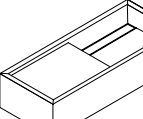

### NOTE

Ogni elemento della composizione può essere acquistato singolarmente o in abbinamento e personalizzato con i prodotti Mirage® indicati alle pagine 99-111. Tutti i mobili sono forniti di idonei agganci. Non sono invece inclusi nella fornitura agganci chimici e accessori (rubinetteria, miscelatori). Contattare l'ufficio Engineering per informazioni sull'ancoraggio degli elementi.

Each element of the composition can be purchased individually or to match, and can be produced with all the Mirage® products indicated on pages 99-111. All furniture items are supplied with the appropriate hardware necessary for mounting. Resin-injected fittings and accessories (taps, mixer taps), are not included. For further details on elements' anchoring please contact Mirage Engineering Division.

# > WONDER

Consolle con lavabo/i integrati  
Console with built-in washbasin/s



Consolle con lavabo/i integrati e mensola in quercia (opzionale).

Console with built-in washbasin/s and shelf in oak (optional).

Konsole mit integrierten/m Waschbecken und Fach aus Eichenholz (optional).

Console avec lavabo/s intégrés et étagère en chêne (en option).

配有一体式盥洗盆和栎木搁板(可选)的条案

## CONSOLE LAVABO SINGOLO | CONSOLE WITH SINGLE WASHBASIN

cod. WD90



cod. WD120

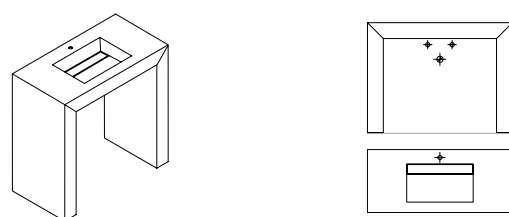

cod. WD120S

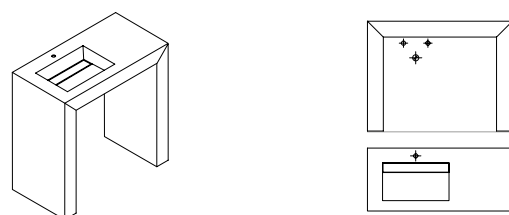

cod. WD120D

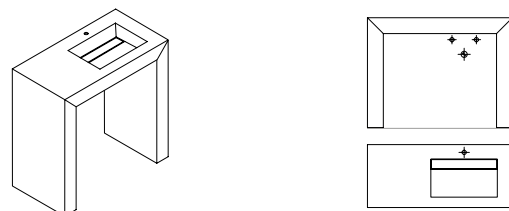

### NOTE

Ogni elemento della composizione può essere acquistato singolarmente o in abbinamento e personalizzato con i prodotti Mirage® indicati alle pagine 99-111. Tutti i mobili sono forniti di idonei agganci. Non sono invece inclusi nella fornitura agganci chimici e accessori (rubinetteria, miscelatori). Contattare l'ufficio Engineering per informazioni sull'ancoraggio degli elementi.

Each element of the composition can be purchased individually or to match, and can be produced with all the Mirage® products indicated on pages 99-111. All furniture items are supplied with the appropriate hardware necessary for mounting. Resin-injected fittings and accessories (taps, mixer taps), are not included. For further details on elements' anchoring please contact Mirage Engineering Division.

cod.	L (cm)	L int. (cm)	P (cm)	H (cm)	price
WD90	90 36"	64 25,2"	51,5 20,3"	90 36"	C6
WD120	120 48"	94 37"	51,5 20,3"	90 36"	C6
WD120S	120 48"	94 37"	51,5 20,3"	90 36"	C6
WD120D	120 48"	94 37"	51,5 20,3"	90 36"	C6
WD140	140 56"	114 44,8"	51,5 20,3"	90 36"	C7
WD140S	140 56"	114 44,8"	51,5 20,3"	90 36"	C7
WD140D	140 56"	114 44,8"	51,5 20,3"	90 36"	C7
WDD160	160 64"	134 52,7"	51,5 20,3"	90 36"	D3
WDD180	180 72"	154 60,6"	51,5 20,3"	90 36"	D5
<b>DIMENSIONE INTERNA LAVABO</b>	<b>55</b>	<b>-</b>	<b>31</b>	<b>-</b>	
<b>WASHBASIN INTERNAL DIMENSION</b>	<b>21,6"</b>	<b>-</b>	<b>12,2"</b>	<b>-</b>	

## Bathmood

## CONSOLE LAVABO SINGOLO | CONSOLE WITH SINGLE WASHBASIN

cod. WD140

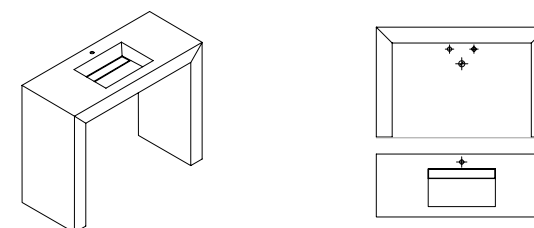

cod. WD140S

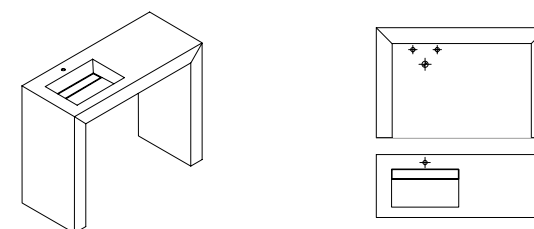

cod. WD140D

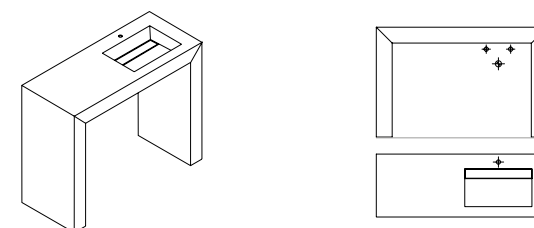

## CONSOLE DOPPIO LAVABO | CONSOLE WITH DOUBLE WASHBASIN

cod. WDD160

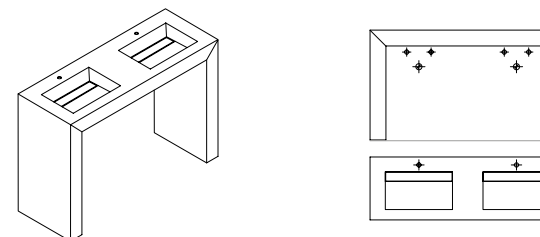

cod. WDD180

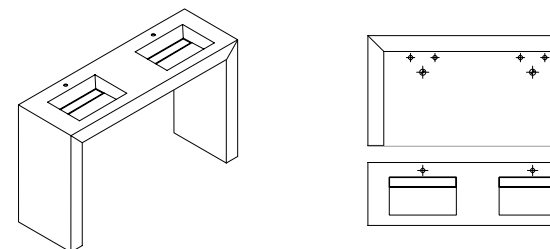

## MENSOLA IN QUERCIA | SHELF IN OAK

cod. WDM54

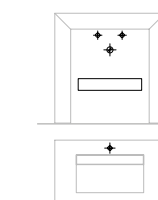
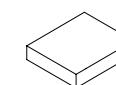

cod. WDM84

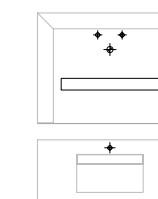
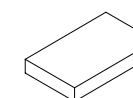

cod. WDM104

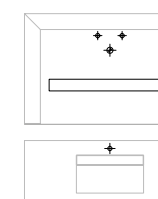
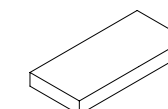

cod. WDM124

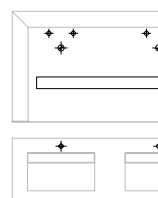
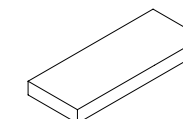

cod. WDM144

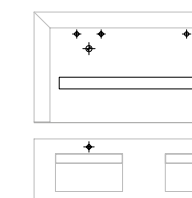
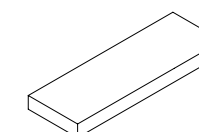

cod.	L (cm)	P (cm)	H (cm)	price
WDM54	54 21,3"	51,5 20,3"	10,5 4,1"	A5
WDM84	84 33"	51,5 20,3"	10,5 4,1"	A6
WDM104	104 41"	51,5 20,3"	10,5 4,1"	A7
WDM124	124 48,8"	51,5 20,3"	10,5 4,1"	A8
WDM144	144 56,7"	51,5 20,3"	10,5 4,1"	A9





**Specchio completo di due luci LED 4000k sopra e sotto.  
Telaio in acciaio e profili laterali in gres porcellanato Mirage (fornito).**

Mirror with two 4000k LED lights (top and bottom).  
Steel frame and side profiles in Mirage porcelain stoneware (frame supplied).

Spiegel mit zwei Lampen LED 4000k oben und unten.  
Rahmen aus Stahl und seitliche Profile aus Mirage Feinsteinzeug (mitgeliefert).

Miroir équipé de deux lampes LED 4000k au-dessus et au-dessous.  
Cadre en acier et profils latéraux en grès Mirage (fourni).

镜子带上下两个4000k的LED灯。  
不锈钢框架和珐瓷侧边（一并提供）。

## SPECCHI ORIZZONTALI | HORIZONTAL MIRRORS

cod. MR9072



cod. MR12072



cod. MR14072

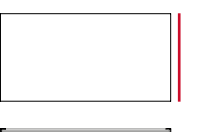

cod. MR16072

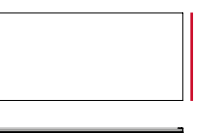

cod. MR18072

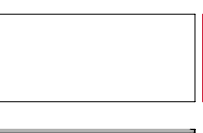

**Rivestimento in gres porcellanato**  
Porcelain stoneware covering

cod.	L (cm)	P (cm)	H (cm)	price
MR9072	90 36"	3,8 1,5"	72 28,4"	A2
MR12072	120 48"	3,8 1,5"	72 28,4"	A3
MR14072	140 56"	3,8 1,5"	72 28,4"	A4
MR16072	160 64"	3,8 1,5"	72 28,4"	A5
MR18072	180 72"	3,8 1,5"	72 28,4"	A6

### NOTE

Ogni elemento della composizione può essere acquistato singolarmente o in abbinamento e personalizzato con i prodotti Mirage indicati alle pagine 99-111. Tutti i mobili sono forniti di idonei agganci. Non sono invece inclusi nella fornitura agganci chimici e accessori (rubinetteria, miscelatori). Contattare l'ufficio Engineering per informazioni sull'ancoraggio degli elementi.

Each element of the composition can be purchased individually or to match, and can be produced with all the Mirage products indicated on pages 99-111. All furniture items are supplied with the appropriate hardware necessary for mounting. Resin-injected fittings and accessories (taps, mixer taps), are not included. For further details on elements' anchoring please contact Mirage Engineering Division.

## SPECCHI VERTICALI | VERTICAL MIRRORS

cod. MR4580

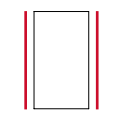

cod. MR4590

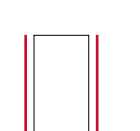

cod. MR6090

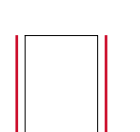

cod. MR7072

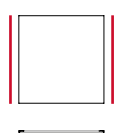

**Rivestimento in gres porcellanato**  
Porcelain stoneware covering

cod.	L (cm)	P (cm)	H (cm)	price
MR4580	45 18"	3,8 1,5"	80 32"	A1
MR4590	45 18"	3,8 1,5"	90 36"	A2
MR6090	60 24"	3,8 1,5"	90 36"	A2
MR7072	70 28"	3,8 1,5"	72 28,4"	A2

## SPECCHI TONDI | ROUND MIRRORS

cod. MRØ90

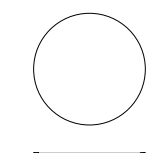

cod. MRØ100

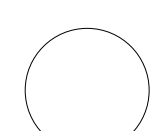

cod. MRØ110

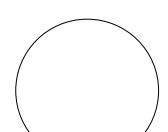

# > APPEAL

Piatto doccia  
Shower tray



**Piatto doccia con scarico centrale e doga removibile.**

Shower tray with central drain and removable cover.

Duschbecken mit Abfluss in der Mitte und abnehmbarer Einlage.

Collecteur de douche avec évacuation centrale et latte amovible.

淋浴盆带中间排水和可拆卸长条。

cod.	L (cm)	P (cm)	H (cm)	price
APQ80	80 32"	80 32"	6 2,4"	B5
APQ90	90 36"	90 36"	6 2,4"	B5
APR80120	120 48"	80 32"	6 2,4"	B7
APR90120	120 48"	90 36"	6 2,4"	B7
APR80140	140 56"	80 32"	6 2,4"	B8
APR90140	140 56"	90 36"	6 2,4"	B8
APR80160	160 64"	80 32"	6 2,4"	B9
APR90160	160 64"	90 36"	6 2,4"	B9
APR80180	180 72"	80 32"	6 2,4"	C3
APR90180	180 72"	90 36"	6 2,4"	C3

## PIATTO DOCCIA | SHOWER TRAY

cod. APQ80



cod. APQ90

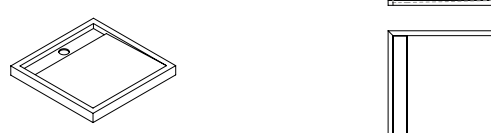

cod. APR80120 | APR90120

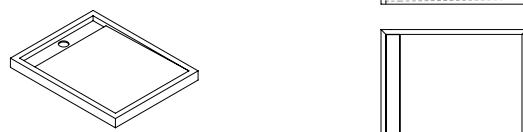

cod. APR80140 | APR90140

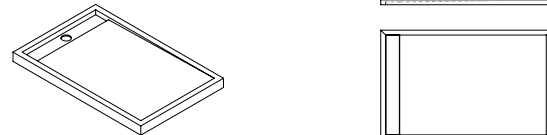

cod. APR80160 | APR90160

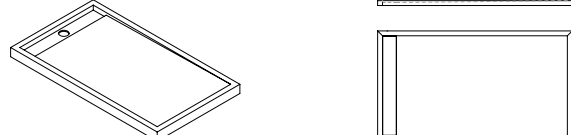

cod. APR80180 | APR90180

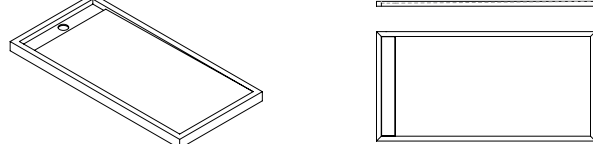

### NOTE

Per la scelta della superficie più idonea, si rimanda alle norme specifiche in relazione all'utilizzo ed alla relativa normativa vigente.

For the selection of the most suitable finish, please refer to the specific rules in relation to the use and the related current legislation.

## Bathmood

# > BALANCE

Colonna con frontale in gres porcellanato  
Column with front panel in porcelain stoneware



**Colonna laccata opaca con frontale in gres porcellanato e ripiani interni in cristallo.**

Matt lacquered column with front panel in porcelain stoneware and glass shelves inside.

Matt lackierter Hochschrank mit Vorderseite aus Feinsteinzeug und Fächern innen aus Glas.

Colonne laquée opaque avec façade en grès cérame et tablettes internes en cristal.

哑光烤漆高柜，配有釉瓷覆面板和内部玻璃层板。

cod.	L (cm)	P (cm)	H (cm)	price
BLR35160	35 14"	34 13,4"	160 64"	B5

## COLONNA | COLUMN

cod. BLR35160

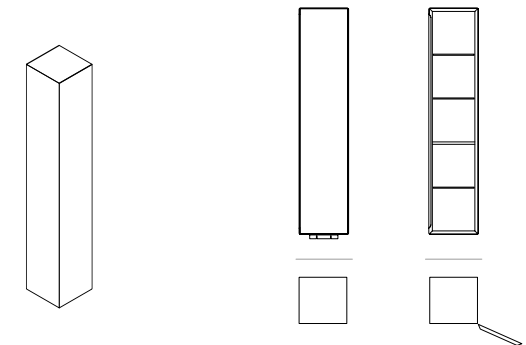

# > FUN

Pensile laccato opaco con frontale in gres porcellanato  
Laquered wall unit with front panel in porcelain stoneware



**Pensile laccato opaco con frontale in gres porcellanato e ripiani interni in cristallo.**

Laquered wall unit with front panel in porcelain stoneware and glass shelves inside.

Hängeschrank mit Vorderseite aus Feinsteinzeug und Fächern innen aus Glas.

Élément suspendu avec façade en grès cérame et tablettes internes en cristal.

配有釉瓷覆面板和内部玻璃层板的吊柜。

cod.	L (cm)	P (cm)	H (cm)	price
FNR35104	35 14"	23 9"	104 40,1"	B2

## PENSILE | WALL UNIT

cod. FNR35104

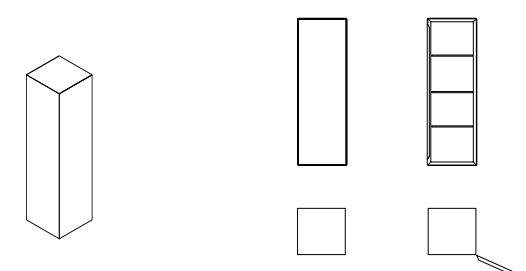



# > SMART

**Cubotto laccato opaco con frontale in gres porcellanato**  
Laquered cuve-shaped with front panel in porcelain stoneware



**Cubotto laccato opaco con frontale in gres porcellanato e ripiani interni in cristallo.**

Laquered cube-shaped unit with front panel in porcelain stoneware and glass shelves inside.

Würfelschrank mit Vorderseite aus Feinsteinzeug und Fächern innen aus Glas.

Cube mural avec façade en grès cérame et tablettes internes en cristal.

配有釉瓷覆面门板和内部玻璃层板的开放式置物格。

cod.	L (cm)	P (cm)	H (cm)	price
SMR5052	50 19,7"	18 7"	52,8 20,8"	A4

## CUBOTTO | CUBE-SHAPED

cod. SMR5052

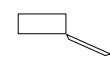

# > STAY

**Seduta**  
Seat



**Seduta con ruote girevoli.**

Seat with rotating wheels.

Sitz mit drehbaren Rädern.

Assise avec roues pivotantes.

带旋转轮的座椅。

cod.	L (cm)	P (cm)	H (cm)	price
STQ40	40 15,7"	40 20,3"	45 18"	A9
STQ60	60 24"	60 24"	45 18"	B4
STR6090	60 24"	90 36,3"	45 18"	B5

## SEDUTA | SEAT

cod. STQ40



cod. STQ60



cod. STR6090

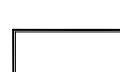
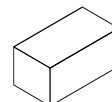

# FINITURE

PRODUCTS | FINITURE | FINITURE | 颜色系列

## EFFETTO MARMO

MARBLE EFFECT  
MARMOROPTIK  
EFFET MARBRE  
大理石效果



## EFFETTO DESIGN

DESIGN EFFECT  
DESIGN OPTIK  
EFFET DESIGN  
设计效果



## EFFETTO CEMENTO

CEMENT EFFECT  
ZEMENTOPTIK  
EFFET CIMENT  
水泥效果



## EFFETTO PIETRA

STONE EFFECT  
STEINOPTIK  
EFFET PIERRE  
石纹效果



### NOTE

Ogni elemento è realizzabile in tutte le finiture di gres porcellanato disponibili in 6 mm di spessore all'interno della gamma Mirage\*. Ulteriori informazioni sono consultabili sul sito [www.mirage.it](http://www.mirage.it)

All elements can be made with all the porcelain stoneware finishes available in the 6 mm thickness in the Mirage\* range. Please refer to [www.mirage.it](http://www.mirage.it) for further information.



# FINITURE

EFFETTO MARMO | MARBLE EFFECT | MARMOROPTIK | EFFET MARBRE | 大理石效果

Statuario  
Extra  
**CP 01**



Calacatta  
Gold  
**CP 02**



Arabescato  
Oro  
**CP 03**



Statuario  
Fantastico  
**CP 04**



White  
Crystal  
**CP 05**



Mystic  
Grey  
**CP 06**



Amazonite  
**CP 07**



Bianco  
Statuario  
**JW 01**



Calacatta  
Reale  
**JW 02**



Royal  
**JW 03**



## Bathmood

100

101



# FINITURE

EFFETTO MARMO | MARBLE EFFECT | MARMOROPTIK | EFFET MARBRE | 大理石效果

Emperador  
Selected  
**JW 05**



Black  
Gold  
**JW 11**



102

Statuario  
Lunensis  
**JW 12**



Gioia  
Whyte  
**JW 13**



Statuario  
Venato  
**JW 14**



## Bathmood

Onyks  
**JW 15**



Raymi  
**JW 16**



Moonless  
**JW 17**



Extra  
White  
**JW 19**

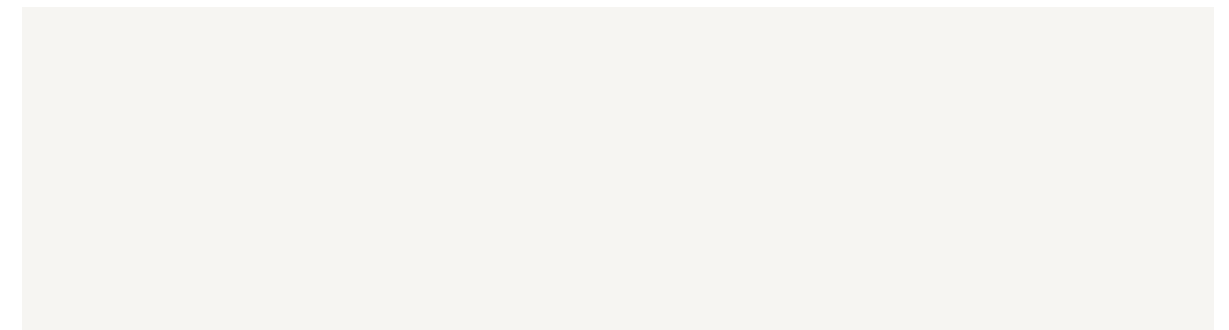

103



# FINITURE

EFFETTO MARMO | MARBLE EFFECT | MARMOROPTIK | EFFET MARBRE | 大理石效果

Calacatta  
Copper  
**WA 01**



Libeccio  
Antico  
**WA 02**



Onice  
Brown  
**WA 03**



Azul  
Puro  
**WA 04**



Labradorite  
**WA 05**



Dark  
Cosmo  
**WA 06**

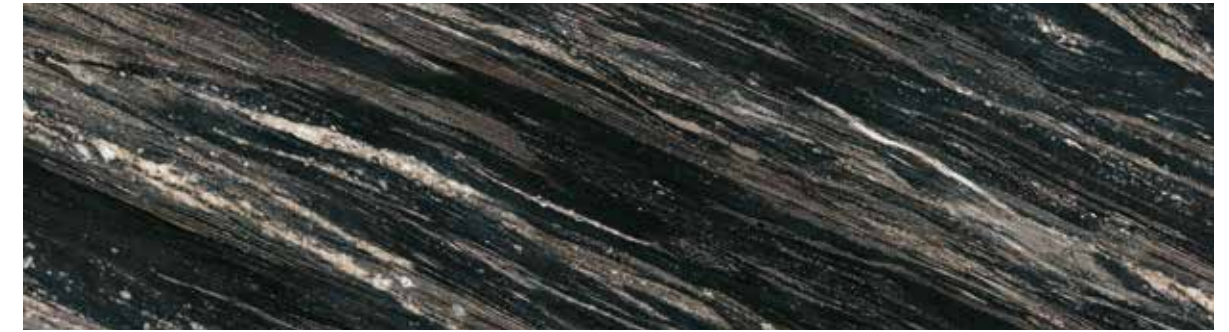

Noir  
Saint Laurent  
**WA 07**

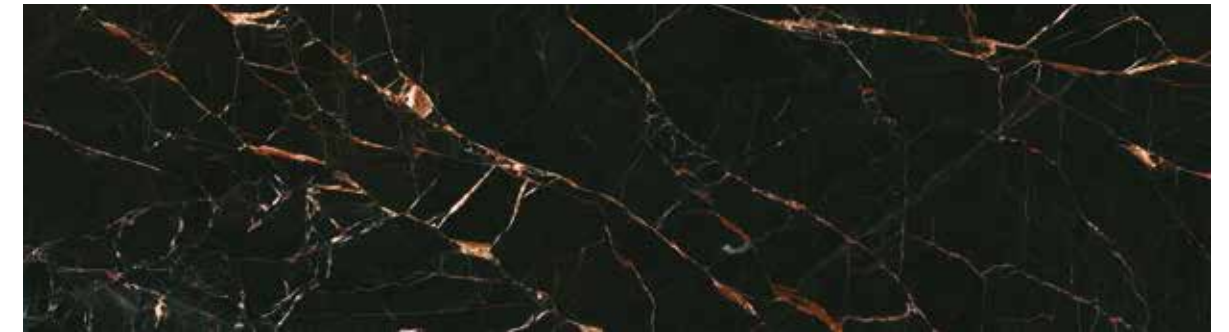

Agata  
Blue  
**WA 08**



Agata  
Multicolor  
**WA 09**



Agata  
Black  
**WA 10**



## Bathmood



# FINITURE

EFFETTO DESIGN | DESIGN EFFECT | DESIGN OPTIK | EFFET DESIGN | 设计效果

Palladium  
**LY 01**



Nimbus  
**LY 02**



Excalibur  
**LY 03**



King  
**LY 09**



Venom  
**LY 04**



Afterglow  
**LY 05**



Iron  
**GC 20**



Corten  
**GC 21**



## Bathmood

# FINITURE

EFFETTO CEMENTO | CEMENT EFFECT | ZEMENTOPTIK | EFFET CIMENT | 水泥效果

Calm  
**CL 01**



Delight  
**CL 02**

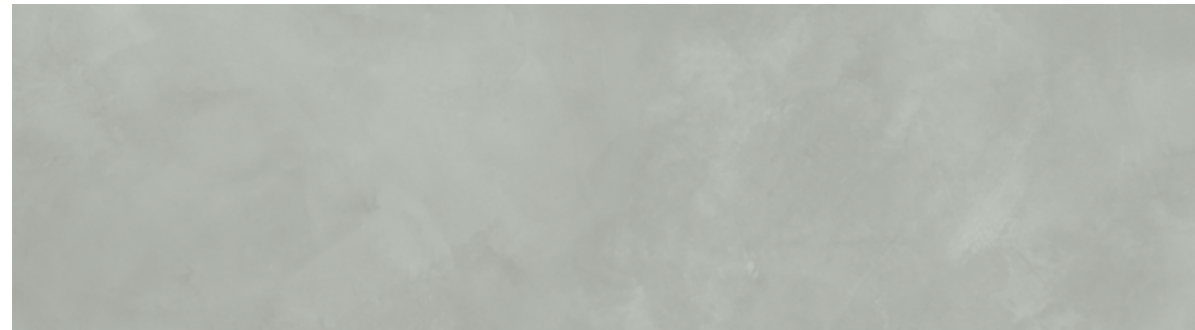

108

Awake  
**CL 03**



Fancy  
**CL 04**

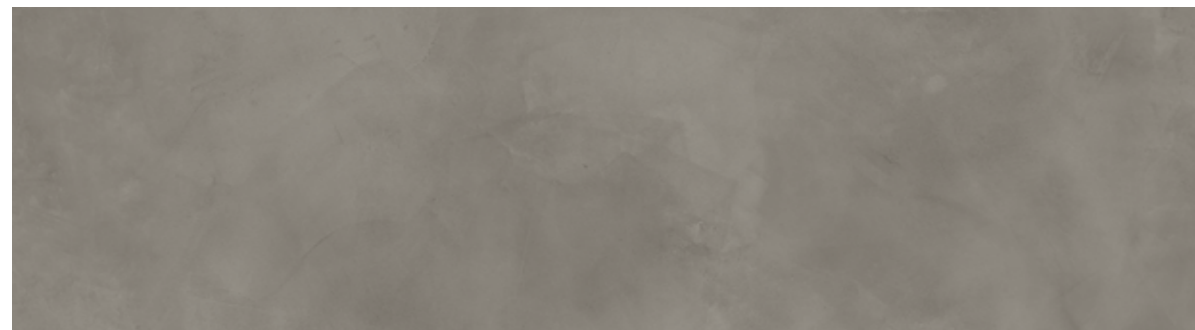

Verve  
**CL 05**



Shy  
**CL 06**



Trust  
**CL 07**



Clear  
**GC 01**



Perfect  
**GC 02**



Ideal  
**GC 03**



## Bathmood

109



# FINITURE

EFFETTO CEMENTO | CEMENT EFFECT | ZEMENTOPTIK | EFFET CIMENT | 水泥效果

Absolute  
**GC 06**



Sugar  
**GC 07**



Chamois  
**GC 08**



Ginger  
**GC 10**



Grå  
**RR 02**



Farge  
**RR 05**



Grå  
Fine  
**RR 12**



Farge  
Fine  
**RR 15**



## Bathmood

# PULIZIA E MANUTENZIONE

CLEANING AND MAINTENANCE | REINIGUNG UND WARTUNG | NETTOYAGE ET ENTRETIEN | 清洁与保养

Pulizia e manutenzione

**PULIZIA E MANUTENZIONE QUOTIDIANA PARTI LACCATE DEL MOBILE (INTERNI E TOP PER BASI SOSPES E)**

Utilizzare una soluzione di sapone liquido neutro non abrasivo (particolarmente consigliato il Sapone di Marsiglia) diluito in acqua tiepida. Usare una soluzione concentrata nel caso in cui le superfici siano molto grasse e sporche. L’ ideale è utilizzare un panno in microfibra inumidito.

**PULIZIA E MANUTENZIONE QUOTIDIANA PARTI IN ESSENZA ROVERE TERMOTRATTATO**

Utilizzare una soluzione di acqua tiepida. L’ ideale è utilizzare un panno in microfibra inumidito leggermente. Successivamente asciugare subito con un panno asciutto evitando aloni o ristagni di umidità.

**AVVERTENZE MOBILI (PARTI LACCATE o ESSENZA)**

- Non usare mai sostanze abrasive che possono graffiare le superficie (detersivi in polvere, paglietta metallica, punte, lame).
- Non usare detergenti contenenti acidi forti (decalcificanti tipo Viakal, pulitori per scarichi), detergenti per forno, sostanze pulitrici per argento, solventi organici come alcool etilico, acetone, trielina.
- Non usare detersivi contenenti ammoniaca, alcool e candeggina.
- Per superfici miste Gres/legno come spigoli dei cassetti e fianchi di mobili non utilizzare prodotti specifici per Gres.

**AVVERTENZE PIATTI DOCCIA LAVABI**

- Non gettare acqua bollente direttamente all’interno dei lavabi, evitando improvvise dilatazioni dovute a shock termico.
- Non utilizzare pulitori per scarichi.

**EVERYDAY CLEANING AND MAINTENANCE OF LACQUERED PARTS OF THE UNIT (INTERIORS AND TOPS FOR WALL-HUNG BASES)**

Use a non-abrasive neutral liquid soap solution (Marseilles soap is highly recommended) diluted in warm water. Use a concentrated solution for very greasy, dirty surfaces. A damp microfibre cloth is ideal.

**EVERYDAY CLEANING AND MAINTENANCE OF LACQUERED PARTS OF THE UNIT (INTERIORS AND TOPS FOR WALL-HUNG BASES)**

**CLEANING AND MAINTENANCE OF PARTS IN HEAT-TREATED OAK**

Use a warm water solution. A slightly damp microfibre cloth is ideal. Dry immediatelly with a dry cloth to avoid leaving marks or humidity.

**EVERYDAY CLEANING AND MAINTENANCE OF LACQUERED PARTS OF THE UNIT (INTERIORS AND TOPS FOR WALL-HUNG BASES)**

**WARNINGS FOR UNITS (LACQUERED OR WOOD PARTS)**

- Never use abrasive substances that could scratch the surfaces (powdered detergents, metal sponges, tips, blades).
- Do not use detergents containing strong acids (limescale removers such as Viakal, drain cleaning products), detergents for ovens, cleaning substances for silver, organic solvents such as ethyl alcohol, acetone or trichloroethylene.
- Do not use detergents containing ammonia, alcohol and bleach.
- For mixed stoneware/wood surfaces such as the edges of drawers and the sides of units, do not use specific products for stoneware.

**WARNINGS FOR SHOWER TRAYS AND WASHBASINS**

- Do not pour boiling water directly into washbasins, to avoid sudden dilation caused by thermal shock.
- Do not use drain cleaners.

**TÄGLICHE REINIGUNG UND WARTUNG DER LACKIERTEN MÖBELTEILE (INNERES UND PLATTE BEI HÄNGEUNTERBAUTEN)**

Eine Lösung aus neutraler, nicht scheuernder Flüssigseife (insbesondere wird Kernseife empfohlen), die in lauwarmem Wasser verdünnt wurde. Eine konzentrierte Lösung verwenden, falls die Oberflächen sehr fett und schmutzig sind. Idealerweise ein feuchtes Mikrofasertuch verwenden.

**TÄGLICHE REINIGUNG UND WARTUNG DER TEILE AUS WÄRMEBEHANDELTEM EICHENHOLZ**

Eine lauwarme Wasserlösung verwenden. Idealerweise ein leicht feuchtes Mikrofasertuch verwenden. Sofort mit einem trockenen Tuch abtrocknen, um Spuren oder Feuchtigkeitrückstände zu vermeiden.

**WARNHINWEISE FÜR MÖBEL (LACKIERTE TEILE oder HOLZ)**

- Nie scheuernde Mittel verwenden, die die Oberflächen zerkratzen könnten (Reinigungspulver, Metallschwämme, Spitzen, Klingen).
- Keine stark säurehaltigen Reinigungsmittel (Entkalker wie Viakal, Abflussreiniger), Ofenreiniger, Silberreiniger, organischen Lösungsmittel wie Ethylalkohol, Aceton, Trichlorethen verwenden.
- Keine ammoniak-, alkohol- und bleichmittelhaltigen Reinigungsmittel verwenden.
- Für gemischte Oberflächen aus Feinsteinzeug/Holz wie die Kanten der Schubladen und Möbelseiten keine spezifischen Reiniger für Feinsteinzeug verwenden.

**WARNHINWEISE FÜR DUSCH- UND WASCHBECKEN**

- Kein siedendes Wasser direkt in die Waschbecken gießen, um plötzliche Ausdehnungen aufgrund des Temperaturschocks zu vermeiden.
- Keine Abflussreiniger verwenden.

**NETTOYAGE ET ENTRETIEN QUOTIDIENS DES PARTIES LAQUÉES DU MEUBLE (INTÉRIEURS ET PLAN POUR BASES SUSPENDUES)**

Utiliser une solution de savon neutre non abrasif (le savon de Marseille est particulièrement conseillé) diluée dans de l’eau tiède. Utiliser une solution concentrée dans le cas où les surfaces seraient très grasses et sales. L’idéal est d’utiliser un chiffon en microfibre humide.

**NETTOYAGE ET ENTRETIEN QUOTIDIENS DES PARTIES EN ESSENCE DE ROUVRE THERMO TRAITÉ**

Utiliser une solution d’eau tiède. L’idéal est d’utiliser un chiffon en microfibre légèrement humide. Par la suite, essuyer tout de suite avec un chiffon sec en évitant les auréoles ou les stagnations d’humidité.

**AVERTISSEMENTS POUR MEUBLES (PARTIES LAQUÉES OU ESSENCE)**

- Ne jamais utiliser de substances abrasives pouvant érafler les surfaces (détergents en poudre, éponge métallique, pointes, lames).
- Ne pas utiliser de détergents contenant des acides forts (détartrants type Viakal, déboucheurs), détergents pour four, substances nettoyantes pour argent, solvants organiques comme alcool éthylique, acétone, trichloréthylène.
- Ne pas utiliser de détergents contenant de l’ammoniac/que, alcool et eau de Javel.
- Pour des surfaces mixtes grès/bois comme les arêtes des tiroirs et les côtés des meubles, ne pas utiliser de produits spécifiques pour grès.

**AVERTISSEMENTS POUR RECEVEURS DE DOUCHES ET LAVABOS**

- Ne pas jeter d’eau bouillante directement à l’intérieur des lavabos, en évitant des dilatations soudaines dues à un choc thermique.
- Ne pas utiliser de déboucheurs.

**家具的烤漆部件的日常清洁和维护（壁挂式地柜的内部和顶板）**

使用非研磨性中性皂液（特别推荐使用马赛皂）在温水中稀释的溶液。 如果表面非常油腻和脏污，请使用浓缩溶液。理想的是使用潮湿的超细纤维布。

**EVERYDAY CLEANING AND MAINTENANCE OF LACQUERED PARTS OF THE UNIT (INTERIORS AND TOPS FOR WALL-HUNG BASES)**

**EVERYDAY CLEANING AND MAINTENANCE OF LACQUERED PARTS OF THE UNIT (INTERIORS AND TOPS FOR WALL-HUNG BASES)**

**热处理橡木部件的日常清洁和维护**

使用温水溶液。理想的方法是使用微湿的超细纤维布。然后立即用干布擦干，以免出现条纹或湿气停滞。

**家具警告（烤漆或木材部件）**

切勿使用可能会划伤表面的研磨性物质（粉末清洁剂，钢丝绒，针尖，刀片）。切勿使用含有强酸的清洁剂（Viakal之类的除垢剂，下水道清洁剂），烤箱清洁剂，银器清洁剂，有机溶剂（如乙醇，丙酮，三氯乙烯）。切勿使用含有氨、酒精和漂白剂的清洁剂。对于瓷砖/木质混合的表面，例如抽屉边缘和家具侧板，切勿使用瓷砖专用的清洁产品。

**EVERYDAY CLEANING AND MAINTENANCE OF LACQUERED PARTS OF THE UNIT (INTERIORS AND TOPS FOR WALL-HUNG BASES)**

**WARNINGS FOR UNITS (LACQUERED OR WOOD PARTS)**

**淋浴盆和盥洗盆警告**

**淋浴盆和盥洗盆警告**

切勿将沸水直接倒入盥洗盆中，以免因热冲击而突然膨胀。

切勿使用下水道清洁剂。

## 113



# IMBALLI

PACKAGING | VERPACKUNGEN | EMBALLAGES | 包装

Composizione	Codice	Descrizione	Descrizione Imballo	N. Colli	Peso lordo	Peso netto
Composition	Code	Description	Packaging Descriptions	N° of boxes	Gross weight	Net weight
Zusammensetzung	Artikelnummer	Beschreibung	Beschreibung der Verpackung Descriptions	Frachtstücke	Bruttogewicht	Nettogewicht
Composition	Code	Description	Emballage	N. de colis	Poids brut	Poids net
组成	编号	描述	包装描述	包装数量	毛重	净重
JOY	JY90T	Top scatolare con 1 lavabo integrato completo di staffe per montaggio Box-shaped countertop with 1 built-in washbasin, complete with mounting brackets	Cassa di legno tipo OSB, protezioni interne in polistirolo Wooden crate in OSB, internal cushioning in polystyrene	1	32,7	17,4
	JY120T			1	48,8	22,8
	JY140T			1	54,2	25,2
	JY160T			1	56,3	28,1
	JYD160T	Top scatolare con doppio lavabo integrato completo di staffe per montaggio Box-shaped countertop with double built-in washbasin, complete with mounting brackets		1	62,5	34,3
	JYD180T			1	69,9	36,2
	JY70B	Base sospesa con 1 cassetto completa di ferramenta per il montaggio Wall-mounted vanity unit with 1 drawer, complete with hardware	Scatola in cartone bianca, pannello OSB 8 mm + pannello polistirolo applicati sul fondo, angolari in polistirolo a copertura degli spigoli White cardboard box, 8 mm OSB panel + panel in polystyrene applied on the bottom, corners in polystyrene and edge protection	1	51	36,4
	JY90B	1		58,2	44,2	
	JY120B	1		81,1	50,1	
	JY140B	Base sospesa con 2 cassetti completa di ferramenta per il montaggio Wall-mounted vanity unit with 2 drawers, complete with hardware		1	92	53,2
JY160B	1	103		56,9		
JY180B	1	114	60,7			
FREEDOM	FR90	Monoblocco con 1 lavabo integrato e 1 cassetto Monoblock with 1 built-in washbasin and 1 drawer	Cassa di legno tipo OSB, protezioni interne in polistirolo + Scatola in cartone bianca, pannello OSB 8 mm + pannello polistirolo applicati sul fondo, angolari in polistirolo a copertura degli spigoli Wooden crate in OSB, internal cushioning in polystyrene + White cardboard box, 8 mm OSB panel + panel in polystyrene applied on the bottom, corners in polystyrene and edge protection	2	94,4	55,1
	FR120	Monoblocco con 1 lavabo integrato e 2 cassetti Monoblock with 1 built-in washbasin and 2 drawers		2	104	68,8
	FR140	2		120,6	75	
	FRD160	Monoblocco con doppio lavabo integrato e 2 cassetti Monoblock with double built-in washbasin and 2 drawers		2	13,8	82,2
	FRD180	2		159,8	88,7	
HAPPINESS	HP90T	Top scatolare per lavabo singolo da appoggio Box-shaped countertop for single countertop washbasin	Cassa di legno tipo OSB, protezioni interne in polistirolo Wooden crate in OSB, internal cushioning in polystyrene	1	26,5	11,2
	HP120T			1	42,6	16,6
	HP140T			1	48	19
	HPD160T	Top scatolare per doppio lavabo da appoggio Box-shaped countertop for double countertop washbasin		1	50,1	21,9
	HPD180T			1	57,5	23,7
	HP60L	Lavabo da appoggio rettangolare Rectangular countertop washbasin		1	22,9	12,7

# Bathmood

Composizione	Codice	Descrizione	Descrizione Imballo	N. Colli	Peso lordo	Peso netto			
Composition	Code	Description	Packaging Descriptions	N° of boxes	Gross weight	Net weight			
Zusammensetzung	Artikelnummer	Beschreibung	Beschreibung der Verpackung Descriptions	Frachtstücke	Bruttogewicht	Nettogewicht			
Composition	Code	Description	Emballage	N. de colis	Poids brut	Poids net			
组成	编号	描述	包装描述	包装数量	毛重	净重			
WISH	WH90	Top scatolare con lavabo integrato completo di staffe per montaggio Box-shaped countertop with built-in washbasin, complete with mounting brackets	Cassa di legno tipo OSB, protezioni interne in polistirolo Wooden crate in OSB, internal cushioning in polystyrene	1	47	22,5			
	WH120			1	57,4	28,2			
	WH140			1	63,5	32,1			
	WH90			1	47	22,5			
	WH120			1	57,4	28,2			
	WH140			1	63,5	32,1			
	GLAMOUR			GM90	Monoblocco con 1 lavabo integrato e 1 cassetto Monoblock with 1 built-in washbasin and 1 drawer	Scatola in cartone bianca, pannello OSB 8 mm applicato sul fondo, angolari in polistirolo a copertura degli spigoli White cardboard box, 8 mm OSB panel applied on the bottom, corners in polystyrene and edge protection	1	68,3	54,3
				GM120	1		94,8	63,9	
GM140		Monoblocco con 1 lavabo integrato e 2 cassetti Monoblock with 1 built-in washbasin and 2 drawers	1	107,8	74,1				
GM160		1	121,2	96,4					
GLAD	GS90	Monoblocco con 1 lavabo integrato e 1 cassetto Monoblock with 1 built-in washbasin and 1 drawer	Scatola in cartone bianca, pannello OSB 8 mm applicato sul fondo, angolari in polistirolo a copertura degli spigoli White cardboard box, 8 mm OSB panel applied on the bottom, corners in polystyrene and edge protection	1	90,8	51,4			
	GD120	Monoblocco con 1 lavabo integrato e 2 cassetti Monoblock with 1 built-in washbasin and 2 drawers		1	99,8	64,6			
	GD140			1	116,1	70,4			
	GD160	1		127,3	77,4				
	GDS90	Stainless steel base		1	20,4	6,3			
	GDS120			1	38,2	7,1			
	GDS140			1	46,9	7,9			
	GDS160			1	50,2	8,3			
COMFORT	CF50	Lavabo freestanding Freestanding washbasin	Cassa di legno tipo OSB, protezioni interne in polistirolo Wooden crate in OSB, internal cushioning in polystyrene	1	83	49,2			
DELIGHT	DLQ50	Lavabo freestanding Freestanding washbasin	Cassa di legno tipo OSB, protezioni interne in polistirolo Wooden crate in OSB, internal cushioning in polystyrene	1	92,5	64,9			

114

115

# IMBALLI

PACKAGING | VERPACKUNGEN | EMBALLAGES | 包装

Composizione	Codice	Descrizione	Descrizione Imballo	N. Colli	Peso lordo	Peso netto
Composition	Code	Description	Packaging Descriptions	N° of boxes	Gross weight	Net weight
Zusammensetzung	Artikelnummer	Beschreibung	Beschreibung der Verpackung Descriptions	Frachtstücke	Bruttogewicht	Nettogewicht
Composition	Code	Description	Emballage	N. de colis	Poids brut	Poids net
组成	编号	描述	包装描述	包装数量	毛重	净重
WONDER	WD90	Consolle con 1 lavabo integrato completo di staffe per montaggio Console with 1 built-in washbasin, complete with mounting brackets	Scatola in cartone bianca, pannello OSB 8 mm applicato sul fondo, angolari in polistirolo a copertura degli spigoli White cardboard box, 8 mm OSB panel applied on the bottom, corners in polystyrene and edge protection	1	99,6	59,7
	WD120			1	115,7	64,1
	WD140			1	124,3	67,3
	WD160	Consolle con doppio lavabo integrato completo di staffe per montaggio Console with double built-in washbasin, complete with mounting brackets		1	135,9	73,5
	WD180			1	144,2	76,8
	WDM54			1	19,2	5,2
	WDM84	Mensola in quercia Shelf in oak		1	21,7	6,7
	WDM104			1	23,1	7,8
	WDM124			1	24,6	8,9
	WDM144			1	25,3	9,8
GLEE	GE70	Cassettiera con 1 cassetto completa di staffe per montaggio Drawer unit with 1 drawer complete with fixing brackets	Scatola in cartone bianca, pannello OSB 8 mm applicato sul fondo, angolari in polistirolo a copertura degli spigoli White cardboard box, 8 mm OSB panel applied on the bottom, corners in polystyrene and edge protection	1	54,2	39,6
	GE90			1	62,3	48,3
	GE120	Cassettiera con 2 cassetti completa di staffe per montaggio Drawer unit with 2 drawers complete with fixing brackets		1	86,6	55,5
	GE140			1	98,4	64,8
	GE160			1	110,7	85,9
	GE180			1	124,6	96,9
STAY	STQ40	Seduta con ruote girevoli Seat with rotating wheels	Scatola in cartone bianca, pannello OSB 8 mm applicato sul fondo, angolari in polistirolo a copertura degli spigoli White cardboard box, 8 mm OSB panel applied on the bottom, corners in polystyrene and edge protection	1	43,5	27,9
	STQ60			1	72,0	48,3
	STR6090			1	102,1	65,1
SMART	SMR5052	Cubotto Cube-shaped	Scatola in cartone bianca, pannello OSB 8 mm applicato sul fondo, angolari in polistirolo a copertura degli spigoli White cardboard box, 8 mm OSB panel applied on the bottom, corners in polystyrene and edge protection	1	29,8	15,7
BALANCE	BLR35160	Colonna Column		1	35,2	19,8
FUN	FNR35104	Pensile Wall unit		1	56,1	35,2

Composizione	Codice	Descrizione	Descrizione Imballo	N. Colli	Peso lordo	Peso netto
Composition	Code	Description	Packaging Descriptions	N° of boxes	Gross weight	Net weight
Zusammensetzung	Artikelnummer	Beschreibung	Beschreibung der Verpackung Descriptions	Frachtstücke	Bruttogewicht	Nettogewicht
Composition	Code	Description	Emballage	N. de colis	Poids brut	Poids net
组成	编号	描述	包装描述	包装数量	毛重	净重
APEAL	APQ80	Piatto doccia quadrato Square shower tray	Cassa di legno tipo OSB, protezioni interne in polistirolo Wooden crate in OSB, internal cushioning in polystyrene	1	37,3	23,8
	APQ90			1	43,9	27,9
	APR120	Piatto doccia rettangolare Rectangular shower tray		1	58	37
	APR140			1	59,3	39
	APR160			1	63,1	42,3
	APR180			1	70,7	46,4
BLISS	MR9072	Specchio retroilluminato orizzontale con profili in gres Back-lit horizontal mirror with edging in porcelain stoneware	Scatola in cartone bianca con protezioni interne in polistirolo White cardboard box with internal cushioning in polystyrene	1	10,1	4,1
	MR12072			1	13,5	5,5
	MR14072			1	15,7	6,4
	MR16072			1	17,9	7,4
	MR18072			1	20,21	8,2
	MR4580	Specchio retroilluminato verticale con profili in gres Back-lit vertical mirror with edging in porcelain stoneware		1	5,6	2,3
	MR4590			1	5,7	2,4
	MR6090			1	8,1	3,3
	MR7072	Specchio retroilluminato tondo Back-lit round mirror		1	7,9	3,2
	MR090			1	11,9	3,9
	MR0100			1	13,1	4,9
MR0110	1		14,6	5,6		

116

117



# IMBALLI

PACKAGING | VERPACKUNGEN | EMBALLAGES | 包装

Composizione Composition Zusammensetzung Composition 组成	Codice Code Artikelnummer Code 编号	Descrizione Description Beschreibung Description 描述	Descrizione Imballo Packaging Descriptions Beschreibung der Verpackung Descriptions Emballage 包装描述	N. Colli N° of boxes Frachtstücke N. de colis 包装数量	Peso lordo Gross weight Bruttogewicht Poids brut 毛重	Peso netto Net weight Nettogewicht Poids net 净重
EASE	ES70	Top scatolare per lavabo da appoggio in legno essenza quercia completo di staffe per montaggio Box-shaped countertop for countertop washbasin in oak wood, complete with fixing brackets	Scatola in cartone bianca, pannello OSB 8 mm applicato sul fondo, angolari in polistirolo a copertura degli spigoli White cardboard box, 8 mm OSB panel applied on the bottom, corners in polystyrene and edge protection	1	99,6	59,7
	ES80			1	115,7	64,1
	ES90			1	124,3	67,3
	ES100			1	135,9	73,5
	ES110			1	144,2	76,8
	ES120			1	19,2	5,2
	ES130			1	21,7	6,7
	ES140			1	23,1	7,8
	ES150			1	24,6	8,9
	ESD160			1	25,3	9,8
	ESD170			1	24,6	8,9
	ESD180			1	24,6	8,9
	ESD190			1	24,6	8,9
ESD200	1	24,6	8,9			

# Bathmood

# GRES PORCELLANATO MIRAGE CARATTERISTICHE TECNICHE

TECHNICAL SPECIFICATIONS | TECHNISCHE EIGENSCHAFTEN | CARACTÉRISTIQUES TECHNIQUES | 技术特征

## STANDARD EN 14411 - G

CARATTERISTICHE TECNICHE TECHNICAL DATA TECHNISCHE DATEN CARACTÉRISTIQUES TECHNIQUES 技术特征	NORMA STANDARD NORM NORME 标准	VALORI PRESCRITTI DALLE NORME EN 14411 - G INTERNATIONAL STANDARDS EN 14411 - G INTERNATIONALE NORMWERTE EN 14411 - G VALEURS PREVUES PAR LES NORMES EN 14411 - G EN 14411 - G标准规定值	*VALORE MEDIO MIRAGE MIRAGE AVERAGE VALUE MIRAGE MITTELWERT VALEURS MOYEN MIRAGE MIRAGE平均值
<b>CARATTERISTICHE DIMENSIONALI</b> SIZE CHARACTERISTICS - MASSEIGENSCHAFTEN DETERMINATION DES CARACTÉRISTIQUES DIMENSIONNELLES - 尺寸特征			
LATI SIDES - SEITEN COTES - 侧边	EN ISO 10545-2	± 0,3% MAX (± 1,0 mm MAX)	CONFORME COMPLYING
SPESSORE THICKNESS - DICKE EPAISSEUR - 厚度	EN ISO 10545-2	± 5,0% MAX (± 0,5 mm MAX)	CONFORME COMPLYING
RETTILINEITÀ DEGLI SPIGOLI STRAIGHTNESS OF SIDES - GERADLINIGKEIT DER KANTEN RECTITUDE DES ARETES - 边角平直度	EN ISO 10545-2	± 0,3% MAX (± 0,8 mm MAX)	CONFORME COMPLYING
ORTOGONALITÀ RECTANGULARITY - RECHTWINKLIGKEIT PERPENDICULARITÉ - 直角度	EN ISO 10545-2	± 0,3% MAX (± 1,5 mm MAX)	CONFORME COMPLYING
PLANARITÀ SURFACE FLATNESS - EBENFLÄCHIGKEIT PLANEITE DE SURFACE - 平整度	EN ISO 10545-2	± 0,4% MAX (± 1,8 mm MAX)	CONFORME COMPLYING
ASSORBIMENTO D'ACQUA WATER ABSORPTION - WASSERAUFNAHME ABSORPTION D'EAU - 吸水率	EN ISO 10545-3	≤ 0,5%	≤ 0,05%
RESISTENZA ALLA FLESSIONE FLEXION RESISTANCE - BIEGEFESTIGKEIT RESISTANCE A LA FLEXION - 抗弯强度	EN ISO 10545-4	S ≥ 700 N (< 7,5 mm) S ≥ 1.300 N (> 7,5 mm) R ≥ 35 N/mm <sup>2</sup> .	12 mm S ≥ 4500 N/mm <sup>2</sup> R ≥ 48 N/mm <sup>2</sup> 6 mm S ≥ 1100 N/mm <sup>2</sup> R ≥ 48 N/mm <sup>2</sup>
RESISTENZA ALL'URTO IMPACT RESISTANCE - STOSSFESTIGKEIT RESISTANCE AUX CHOCS - 抗冲击强度	EN ISO 10545-5	VALORE DICHIARATO DECLARED VALUE	> 0,85
RESISTENZA ALL'ABRASIONE ABRASION RESISTANCE - ABRIEBFESTIGKEIT RESISTANCE A L'ABRASION - 耐磨强度	EN ISO 10545-6	≤ 175 mm <sup>3</sup>	< 145 mm <sup>3</sup>
COEFFICIENTE DI DILATAZIONE TERMICA LINEARE COEFFICIENT OF LINEAR THERMAL EXPANSION - LINEARER WÄRMEAUSSDEHNUNGSKOEFFIZIENT COEFFICIENT DE DILATATION THERMIQUE LINEAIRE - 线性热膨胀系数	EN ISO 10545-8	—	> 6x10 <sup>-4</sup> °C <sup>-1</sup>
RESISTENZA AGLI SBALZI TERMICI RESISTANCE TO THERMAL SHOCKS - BESTÄNDIGKEIT GEGEN TEMPERATURSCHWANKUNGEN RESISTANCE AUX CHOCS THERMIQUES - 耐热突变性	EN ISO 10545-9	TEST SUPERATO SECONDO EN ISO 10545-1 PASS ACCORDING EN ISO 10545-1	NESSUN DANNO NESSUN DAMAGE
RESISTENZA AL GELO FROST RESISTANCE - FROSTBESTÄNDIGKEIT RESISTANCE AU GEL - 耐冻性	EN ISO 10545-12	TEST SUPERATO SECONDO EN ISO 10545-1 PASS ACCORDING EN ISO 10545-1	NESSUN DANNO NESSUN DAMAGE
RESISTENZA ALL'ATTACCO CHIMICO RESISTANCE TO CHEMICALS - CHEMIKALIENBESTÄNDIGKEIT RESISTANCE A L'ATTAQUE CHIMIQUE - 耐化学药品作用	EN ISO 10545-13	UB MIN.	NAT A LA HA LUC A LA SLK A LA SP A LA HA
RESISTENZA ALLE MACCHIE RESISTANCE TO STAINS - FLECKENBESTÄNDIGKEIT RESISTANCE AUX TACHES - 防污性	EN ISO 10545-14	VALORE DICHIARATO DECLARED VALUE	5
CESSIONE DI PIOMBO E CADMIO LEAD AND CADMIUM DISCHARGE - ABGABE VON BLEI UND CADMIUM PERTE DE PLOMB ET CADMIUM - 铅和镉的排放	EN ISO 10545-15	VALORE DICHIARATO DECLARED VALUE	< AL LIMITE DI RILEVAMENTO < THAN INSTRUMENT LIMIT

Per i certificati specifici, contattare Mirage S.p.A.

For specific certificates, please contact Mirage S.p.A.

Für die speziellen Zertifikate wenden Sie sich bitte an Mirage S.p.A.

Pour les certificats spécifiques, veuillez contacter Mirage S.p.A.

关于具体的证书, 请联系Mirage S.p.A.公司

118

119

# NOTE

NOTES

---

120



# MIRAGE<sup>®</sup>

Porcelain.Design.Sustainability

## Mirage Granito Ceramico S.p.a.

### Uffici e Stabilimento

41026 - Pavullo (MO) ITALY  
Via Giardini Nord, 225  
Tel. +39 0536 29611  
Fax +39 0536 21065  
info@mirage.it  
www.mirage.it

### Mirage USA INC.

618 Grassmere Park Dr - Suite 1-2  
Nashville - Tennessee (TN) - 37211  
TAX ID: 75 2773306  
Ph: +1 615-834-3888  
info@mirageusa.net  
www.mirageusa.net

### Mirage Project Point Milano

20121 - Milano ITALY  
Via Marsala, 7  
Tel. +39 02 65560879  
projectpoint-mi@mirage.it  
www.mirageprojectpoint.com/milano

### Mirage Project Point Dubai

Building 7 - Ground Floor  
d3 Dubai Design District  
United Arab Emirates  
Ph. +971 4 554 3944  
Licence No. 93659  
projectpoint-uae@mirage.it  
www.mirageprojectpoint.com/dubai

